

Science

Teacher Guide

Primary

Grade 5



Standards Based



Papua New Guinea
Department of Education

**'FREE ISSUE
NOT FOR SALE'**

Science

Teacher Guide

Primary

Grade 5

Standards Based

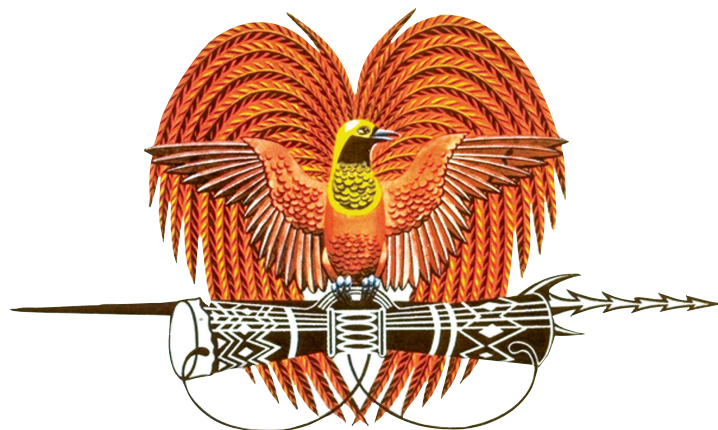

Papua New Guinea
Department of Education

Issued free to schools by the Department of Education

First Edition

Published in 2017 by the Department of Education

© Copyright 2017, Department of Education, Papua New Guinea

All rights reserved. No part of this publication may be reproduced, stored in a retrieval system, or transmitted in any form or any means, electronic, mechanical, photocopying, recording or otherwise without the prior written permission of the publisher.

Graphic Design & Layout by David Kuki Gerega

ISBN 978-9980-86-580-9

Acknowledgements

The Grade 5 Primary Science Teacher Guide was developed by the Curriculum Development Division of the Department of Education. The Teacher Guide development was coordinated by Moses Hatagen Koran with assistance from the Science Subject Committee Group (SCG).

The Department of Education acknowledges contributions from Teachers College Lecturers, Teachers, Standard Officers, resource persons from Non-Government Organisations (NGOs) and other stake holders.

Members of the Syllabus Advisory Committee (SAC) and the Basic Education Board of Studies (BEBoS) are also acknowledged for the recommendation and endorsement of this Teacher Guide.

Contents

Secretary's Message	iv
Introduction	1
Teaching and Learning Strategies	4
Planning and Programming	6
Content Overview	8
Content Background Notes	17
A. Guided Lessons	30
B. Knowledge Skills Attitudes and Values	81
Assessment, Recording and Reporting	87
Resources	96
Glossary	97
References	98
Appendix	99

Secretary's Message

This Science Teacher Guide for Grade 5 was developed as a support document for the implementation of Science syllabus for grades 3, 4 & 5. The document provides guidelines for teachers on how to plan and program teaching and learning activities. It also contains sample guided lessons and assessments tasks with suggested teaching and learning strategies that teachers can use to work towards the achievement of content standards in the syllabus.

The Science subject is fundamental in life and a pillar for the ongoing and future development of this nation. Hence, it is critical to develop the learners' understanding of scientific concepts, skills and processes, and nurture the students' love for Science to enable them to be scientifically literate. This Teachers Guide will help teachers to expand the broad content from the syllabus into teachable programs. It has been designed with a view of making the students understand the basic scientific knowledge and skills in accordance with daily experience and prior knowledge about the environment.

The intention at this level is to set sound foundation for children to learn Science concepts and skills and to gradually develop the love for Science and expand the knowledge and understanding as the progress from one level to another.

Teachers are encouraged to read this teacher guide carefully to become familiar with the content so that they can be confident to try out new concepts and strategies and to teach the content well. They can also adjust to suit the needs of their students.

I commend and approve this Grade 5 Science Teacher Guide to be used in all Primary Schools throughout Papua New Guinea.

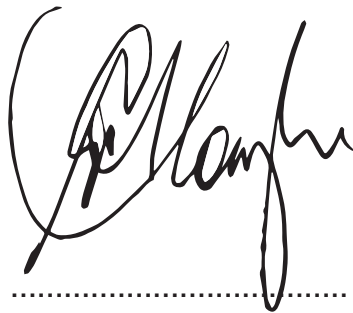

.....
DR. UKE W. KOMBRA, PhD
Secretary for Education

The teacher guide contains helpful information that you should read and familiarize yourselves with before administering actual implementation. The information and guidelines provided in this teacher guide will assist you to interpret and translate the content prescribed in the Primary Grades 3, 4 & 5 Syllabus into teachable activities. This book provides a guide for you to use the suggested teaching and learning ideas to plan quality science lessons and when, where and how to use benchmarks in relation to the attainment of standards.

The teacher guide also guides you on how to create and design active and interactive teaching and learning environment. It contains samples of assessment tasks that will help you to create assessment tasks that can be measured against the intended content standard. The teacher guide will give you an opportunity to prepare learning activities that will motivate students to think critically and communicate ideas freely with other students in their classes.

The content of this teacher guide features the following:

- key features of the subject,
- teaching and learning strategies,
- planning and programming – weekly plan and daily plan,
- content overview – yearly and termly overview,
- unit content background information,
- samples of guided lessons,
- assessment and reporting of the subject and,
- resource materials.

How to use the Teacher Guide

You are encouraged to use this teacher guide as the main reference to plan and implement the grade 5 contents as prescribed in the Primary Grades 3,4 & 5 Science syllabus. For effective implementation of Science in Grade 5, you are encouraged to do the following:

1. Read the teacher guide thoroughly and carefully.
2. Read the syllabus and become familiar with strands, units, content standards and performance standards which are expanded in the teacher guide.
3. Take note of ideas, strategies, and processes that you feel comfortable with and those you find difficulty with.
4. Meet with other teachers, discuss and share ideas about how to:
 - Use the teacher guide to do planning for the year's instructional programs.
 - Conduct in-services on sections of the teacher guide to assist other teachers.
 - Share ideas with other stake holders about the teacher guide.

Key Features

The key features outlined in this section are identified as unique to Science and are important in the planning and teaching of Science. The key features of the Grades 3, 4 & 5 Science curriculum emphasises recommended knowledge, skills and processes and provide ideas on how to teach practical science and its' theories without a laboratory and practical Science.

Using the senses

Most people don't know what a scientist really does. Many people think a scientist spends his day mixing up chemicals in a laboratory. But a scientist is really like a detective. The scientist wants to find out why things happen. He or she starts by looking for clues. The scientist observes things very carefully. He or she uses the five senses to collect information.

Scientists describe the things they observe and they write down descriptions. They do the experiments and often they measure things. They collect results and record them. If they are not satisfied with their results, they repeat the same experiment.

Scientific Processes and Skills

Scientific inquiry may be defined as the activities and processes which scientists and students engage in to study the natural and physical world around them. In its simplest form, scientific inquiry may be seen as consisting of two critical aspects: the what (content) and the how (process) of understanding the world we live in. Teaching science as inquiry must therefore go beyond merely presenting the facts and the outcomes of scientific investigations. Students need to be shown how the products of scientific investigations were derived by scientists and be provided opportunities to:

- ask questions about knowledge and issues that relate to their daily lives, society and the environment
- be actively engaged in the collection and use of evidence
- formulate and communicate explanations based on scientific knowledge.

Through inquiry learning, students will be able to acquire knowledge and understanding of their natural and physical world based on investigations, apply the skills and processes of inquiry and develop attitudes and values that are essential to the practice of science.

Introduction

The table below shows the degree of responsibility students have in posing and responding to questions, designing investigations, and evaluating and communicating their learning (student-directed inquiry) in an inquiry – based learning compared to the degree of involvement of the teacher (teacher-guided inquiry).

Essential features of Science as Inquiry	Amount of Student Self-Direction ←————→ Amount of Guidance from Teacher Or Material			
	More ←————→ Less			Less ←————→ More
1. Question Students engage with an event, phenomenon or problem when they	pose a question	select among questions	sharpen or clarify questions provided	accept given questions
2. Evidence Students give priority to evidence when they	determine what constitutes evidence and collect it	are directed to collect certain data	are given data and told how to analyse	are given data and told how to analyse
3. Explanation Students construct explanations when they....	formulate their own explanation after summarizing evidence	are guided in process of formulating explanation from evidence	are given possible ways to use evidence to formulate explanation	are provided with evidence
4. Connection Students evaluate their explanations when they...	examine other resources and form links to explanations	are directed toward sources of knowledge	are given possible connections	are provided with connections
5. Communication Students communicate and justify their explanations when they.....	form reasonable and logical arguments to communicate explanations	are coached in development of communication	are provided guidelines for communication	are given steps and procedures for communication

Adapted from *Inquiry and the National Science Education Standards*, National Research Council (2000)

Science without a laboratory

Science processes and procedures can be taught and learned without a conventional Science laboratory. Science without a laboratory is a reality for Papua New Guinea primary schools. With this in mind, the Grades 3, 4 & 5 Science Syllabus with the Teacher Guides have been specifically designed to assist you to plan and design worthwhile learning opportunities for all students irrespective of the school's location.

Students and teachers are encouraged to use the resources that are readily available to them in their own surroundings. Students' safety is of great importance and should be guaranteed before actually using the improvised material. Local knowledge and situations become very important in this approach.

Teaching and Learning Strategies

A primary purpose for inquiry – based instruction is for students to learn fundamental science concepts, principles, and theories as well as to develop science process skills and attitudes that are essential for scientific inquiry. Science teachers are already using a variety of teaching and learning strategies in their lessons. These strategies can be mixed and matched.

Concept Cartoon - In concept cartoons, minimal language is used. Visual images are utilised to present concepts or questions relating to one central idea or word.

Concept Mapping- Concept mapping is a strategy to present meaningful relationships among concepts. Concept maps are useful in organising and linking concepts or ideas.

Cooperative Learning - In cooperative learning, activities are structured such that each student assumes certain responsibilities and contributes to the completion of tasks. In working with others, students are exposed to different points of views and solutions in accomplishing a common goal.

Demonstration is commonly used to scaffold the learning process. This approach is recommended when the learning activity is not safe or too complex for students to set up on their own.

Field Trip - A field trip is any learning activity outside the school. It provides opportunities for students to explore, discover and experience science in everyday life.

Games - engage students in play or simulations for the learning of concepts or skills. This is useful in helping students to visualise or illustrate objects or processes in the real world.

Investigation - In scientific investigation, students engage in activities that mirror how scientists think and what they do in a decision making process, such as asking or posing questions and planning or designing investigations.

Problem Solving - Problem solving engages students in finding solutions to problems by applying scientific knowledge and skills.

Projects - are learning activities that require students to find out about an object, event, process or phenomenon over a few weeks.

Questioning- Questions are useful tools in the scientific inquiry process. Both teachers and students should engage in cycles of questions-answers-questions throughout the learning process.

Role Play, Drama, Dance and Movement - Role play, drama, dance and movement allow students to express their understanding of scientific concepts and processes in a creative way.

Strategies for Active and Independent Learning (SAIL)

The SAIL approach emphasises learning as a formative and developmental process in which instruction and assessment point the way for students to continuously learn and improve. Learning expectations and rubrics are used to describe what students should know and be able to do. This would help students know where they are in the learning process and how they can improve.

Information and Communication Technologies (ICT)

ICT supports the inquiry process and also facilitates student collaboration and self- directed learning. For example, online collaborative tools allow students to share and discuss their ideas or findings within the school, and also extend their learning through consulting field experts. Internet enabled devices could be used to facilitate data collection and analysis in situated learning. Students can also explore and visualise abstract concepts using simulations tools to manipulate the variables to deduce a relationship between the variables.

Teaching and Learning Strategies

What are some features of an inquiry classroom?

An inquiry classroom is visibly different from a traditional classroom in the following ways:

Inquiry Classroom	Traditional Classroom
Students often work in groups	Students tend to work alone
Emphasis on understanding of concepts	Emphasis on mastery of facts
Allows for pursuit of student questions	Follows a fixed curriculum closely
Activities rely on a variety of sources	Activities rely mainly on textbooks and workbook materials
Students are viewed as thinkers with their own theories about the world	Students are viewed as “ blank slates ”
Teachers facilitate an interactive learning environment	Teachers tend to disseminate information to students
Teachers seek to understand student learning	Teachers tend to seek correct answers
Assessment is interwoven with teaching	Assessment tends to be separate from teaching

Adapted from *In Search of Understanding: The Case for Constructivist Classrooms*, Brooks & Brooks (1993).

Although participation by students in hands-on activities is desirable, it is equally important that they are mentally engaged with scientific reasoning and methods. Research indicates that science process skills are best learnt when used to understand specific scientific content. Understanding content without process or vice versa is insufficient to nurture students as inquirers.

Safety for Primary Students

When teaching Science teachers must ensure that students know how to follow safety guidelines and handle apparatus with care. Safety must be given the highest priority for the benefit of the children and the Science lesson.

Correct and safe techniques, as well as a wise selection of experiments, resources, materials, and field experiences appropriate to age levels, must be carefully considered regarding the safety precautions for every instructional activity.

While no comprehensive list exists to cover all situations, the following should be reviewed to avoid potential safety problems. Appropriate safety procedures should be used in the following situations:

- observing wildlife; handling living and preserved organisms; and coming in contact with natural hazards, such as poison ivy, ticks, mushrooms, insects, spiders, poisonous plants and snakes,
- engaging in field activities in, near, or over bodies of water,
- handling glass tubing and other glassware, sharp objects, and lab ware,
- handling natural gas burners, Bunsen burners, and other sources of flame/heat,
- working in or with direct sunlight (sunburn and eye damage),
- handling chemicals and other hazardous substances.

Students with special needs (Inclusive Learning)

Some students have special needs. This includes students who are gifted and those who are disadvantaged. Gifted students should be given opportunities to extend their learning. Students with physical or intellectual impairments and emotional or learning difficulties need special support in the classroom. Teachers have a responsibility to ensure that the learning needs of these students are met. All students are individuals and all have the right to quality education in order to reach their full potential.

Planning and Programming

Planning and Programming is organising the content from the syllabus into teachable plans for delivery in the classroom using approaches such as long, medium, short term plans. For example:

- yearly overview is a long term plan
- termly overview is medium term plan and
- weekly and daily plans are short term plans.

Yearly Plan

When planning an instructional program, we begin with the yearly plan. The yearly plan is organised by terms in a school year. The main or key information that forms the content of the plan are provided in both the syllabus and the teacher guide. These are the;

- strands,
- units and,
- content standards.

Weekly Plan

A weekly plan is a plan of an instruction program for teaching and gives the teacher specific outline of the Units, Content Standards and Performance Standards for instruction (teaching) which the teacher follows in a term. This guides the teacher to organize the teaching program for the number of weeks in each term.

To compile a plan for a week's program teachers will need to organize the plan using the:

- Units
- Content Standards
- Performance Standards
- Lesson titles.

Teachers should use the term overview to see the order of units organised, and then use this order to plan the weekly program. The weekly plan is implemented through a timetable that is planned for the subjects in the Primary level.

Planning and Programming

Timetable

Sample Timetable

Time	Monday	Tuesday	Wednesday	Thursday	Friday
8:00 - 8:15	Assembly	Assembly	Assembly	Assembly	Assembly
8:15 - 8:30	Listening	Oral Expression	Listening	Oral Expression	Listening
8:30 - 9:00	Spelling	Spelling	Mathematics	Spelling	Social Science
9:00 - 9:30	Talking	Talking	Talking	Mathematics	Mathematics
9:30 - 10:00	Written Sentences	Written Sentences	Written Sentences	Written Sentences	Written Sentences
10:00 -10:30	← RECESS →				
10:30 - 11:00	Reading	Reading	Reading	Reading	Reading
11:00 - 11:30	Science	Mathematics	Science	Science	Written Expression
11:30 - 12:00	Social Science	Social Science	Social Science	Science	Social Science
12:00-1:00	← LUNCH →				
1:00 - 1:30	Mathematics	Science	Mathematics	Mathematics	Mathematics
1:30 - 2:00	Health	Science	Health	Arts	Arts
2:00 - 2:30	Arts	Health	PE	PE	Sports
2:30 - 3:00	PE	Arts	Hand writing		

Sample Time break up

Subjects	Time analysis		Time variation			
	Min	Per Less	Recom. Time		+	-
Listening	3	x 15	45			
Talking	4	x 15	60	15		
Oral expression	2	x 15	30			
Reading	5	x 30	150			
Written Sentences	5	x 30	150			
Hand writing	1	x 15	15	15		
Spelling	2	x 15	30	15		
Written Expression	1	x 30	30			
Mathematics	8	x 30	240			
Science	2	x 30 + 2 x 60	180	15		
Social Science	5	x 30	150			
Health	3	x 30	90			30
Arts	3	x 30 + 1 x 45	135			
Physical Education	2	x 30 + 1 x 60	120			
Sports	1	x 60	60			
Religious Education	1	x 60	60			
Assembly	5	x 15	75			
Block Time	3	x 15	45			30
			1650	60		60

Content Overview

This section presents the overview of the Science content scope of learning for grade five. The content is organised into the following :

- Life
- Physical Science and
- Earth and Space.

These broad learning areas are known as **strands**. From these strands units are developed and drawn from the units are topics. The overview below will help you understand the process in identifying the scope of the content of learning – strand, units and topics are translated into content standards.

Here is the scope of learning for grade five.

Content Scope of Learning for Grade 5

Strand	Unit	Grade 3	Grade 4	Grade 5
		Topic	Topic	Topic
Life	Plants	• Plants parts and their functions	• Life cycle of plants	• Plant growth
	Animals	• Animal parts and their functions	• Life cycle of animals	• Reproduction and heredity of animals
	Human Being		• Skeletal and Muscular system	
	Interaction and Relationship in the environment	• Observing our Environment	• Living things in the environment	• Habitat and adaptation • Energy in Food
Physical Science	Energy	• Energy • Light • Magnet	• Sound • Electricity 1	• Heat • Electricity 2
	Force and motion	• Moving objects	• Forces, motion and machines	• Motion and machines
	Matter	• Properties of matter • Substances and mixtures	• Air • Matter changes	• Three states of matter • New matter
Earth and Space	Our Earth	• The Earth • Rocks • Soil	• Importance of soil for human being	• Rocks, minerals and fossils
	Weather and climate		• Observing weather	• Weather and seasons
	Space	• Observing the sun	• Observing the moon	

Content Overview

Yearly Overview

The yearly overview is a plan designed to organise the learning content for grade five students in terms and weeks.

WEEK	TERM 1	TERM 2	TERM 3	TERM 4	
1	Orientation Revision Work	Revision Work	Revision Work	Revision Work	
2	Life	Life	Life	Physical Science	
3	Habitat and Adaptation	Plant Growth	Energy in Food	Energy - Heat	
4	Physical Science	Life	Physical Science	Physical Science	
5	Three states of matter	Reproduction and Heredity of animals	Motion and Machine	Electricity 1	
6					
7		Earth and Space	Physical Science		
8		Weather and Seasons		Earth and Space	Physical and Chemical Change
9				Our Earth	
10	Testing and compiling of Assessment			Assessment & Report Writing	
				Speech Day Preparation	

Content Overview

Termly Overview

The term overview is a plan of an instructional program for teaching. It provides the teacher with the specific units, topics and lesson titles suggested to be planned and delivered within a term. The term overview is organised by:

- Strands
- Units
- Topics.

Term 1 Overview

Week	Strand	Unit	Topic	Lesson Title	Periods/s (30mins)
1	Orientation and Revision Work				
2	Life	Interaction & Relationship In The Environment	Habitat & Adaptation	What Is A Habitat?	1
3				Different Types of Habitat - Seashore	1
				Different Types of Habitat - Rainforest	1
				Different Types of Habitat - Grassland	1
				Different Types of Habitat - Wetland	1
				What Is Adaptation?	1
4				Adaptation of Plants In Different Habitats	1
				Adaptation of Animals In Different Habitats	1
				Physical Structure of Living Things - Feeding	2
5				Physical Structure of Living Things – Movement	2
				Physical Structure of Living Things - Protection From Enemies	2
				Review	1
				Properties of solids	1
6	Physical Science	Matter	Three States Of Matter	Properties of liquids	1
				Properties of gas	1
				Behaviour of particles in solid, liquid and gas	1
				Similarities and differences between solids, liquids and gases	1
				Changing states of water	2
				Changes of states and temperature	2
				Review	1
				Properties of chemical change	1
				Observing chemical change - combustion	1
				Observing chemical change - rusting	1
9	Difference between chemical and physical change	1			
	Review	1			
10	Testing and compiling of marks				

Content Overview

Term 2 Overview

Week	Strand	Unit	Topic	Lesson Title	Periods (30mins)
1	Revision Work				
2	Life	Plants	Plant Growth	Conditions of seed germination	2
				Conditions for plant growth	2
				Compare between conditions of seed germination and plant growth	2
				How plants make their own food	2
				Review	1
4	Life	Animals	Reproduction & heredity of animals	Reproduction process of human beings	1
				Reproduction process of dogs	1
				Reproduction process in birds - chicken	1
				Reproduction process of frogs	1
				Reproduction process of fish	1
				Compare the reproductive process of humans and birds	1
				Hereditary characteristics of animals	1
				Unit review	2
7	Earth and Space	Space	Weather and Seasons	Observing clouds	1
				Types of clouds	2
				Seasons of the World	1
				Characteristics of the seasons	2
				Seasons in PNG	1
				Seasons and living things	2
				Weather, seasons and Plants	1
				Weather, seasons and Animals	2
				Weather, seasons and People	2
				Review	1
10	Testing and compiling of marks				

Content Overview

Term 3 Overview

Week	Strand	Unit	Topic	Lesson Title	Periods (30 mins)
1	Revision Work				
2	Life	Interaction & Relationship	Energy In Food	Living things needs food	1
				Sources of energy for living things	1
3				Animals get their energy from plants	2
				Animals get energy from other animals	2
				Plants get energy from the sun.	1
4				Review	1
5	Physical Science	Force and Motion	Motion and Machines	Balance and Unbalance force	2
				Types of levers	1
6				Parts of a lever	2
				Relationship between distance and force (pivot, load and distance)	2
7				Using a beam balance	2
				Uses of levers in daily life	1
				Review	1
8	Earth and Space	Our Earth	Rocks, Minerals and Fossils	What is a rock?	1
				Sedimentary rocks	2
				Igneous rocks	1
				Metamorphic rocks	1
				Common minerals in PNG	2
				Uses of rocks and minerals	1
				What is a fossil?	1
9				How are fossils formed	1
	Review	1			
10	Testing and compiling of Assessment				

Content Overview

Term 4 Overview

Week	Strand	Unit	Topic	Lesson Title	Periods (30 mins)	
1	Revision Work					
2	Physical Science	Energy	Heat	What is heat?	1	
				Sources of heat	1	
				What can heat can do?	1	
				Heat transfer- Conduction	2	
				Heat transfer- Convection	1	
				Heat transfer- Radiation	1	
3					Uses of heat transfer	1
				Measuring and reading temperature	2	
				Differentiate between heat and temperature	1	
				Review	1	
4	Physical Science	Energy	Electricity 2	Components of a circuit	1	
				Connecting in series circuit	2	
				Connecting in parallel circuit	2	
5				Making a bulb brighter	1	
				Advantages and disadvantages of parallel and series circuit	1	
6				Using symbols to draw circuits	2	
				Uses of circuits in daily life	2	
				Review	1	
7	Physical Science	Matter	Physical and chemical changes	Properties of chemical change	2	
				Observing chemical change - combustion	1	
8				Observing chemical change - rusting	1	
				Difference between chemical and physical change	2	
				Review		
9	Assessment and Report Writing					
10	Preparation for Speech Day					

Content Overview

Yearly Lesson Overview

The yearly lesson overview has the lesson titles which are organised from term 1- 4 for the year. There are **88** lessons altogether including the revision lesson/follow-up lessons. These lesson titles are expected to be taught by throughout the country.

Unit	Topic	Main Topic	Lesson #	Lesson Title
Life	Interaction & Relationship in the Environment	Habitat & Adaptation	1	What is a Habitat?
			2	Different types of Habitat- Seashore
			3	Different types of Habitat- Rainforest
			4	Different types of Habitat- Grassland
			5	Different types of Habitat- Wetland
			6	What is Adaptation?
			7	Adaptation of Plants in different Habitats
			8	Adaptation of Animals in different Habitats
			9	Physical Structure of Living Things- Feeding
			10	Physical Structure of Living Things – Movement
			11	Physical Structure of Living Things- Protection from Enemies
			12	Review
Physical Science	Matter	Three States of Matter	13	Properties of solid
			14	Properties of liquid
			15	Properties of gas
			16	Behaviour of particles in solid, liquid and gas
			17	Similarities and differences between solids, liquids and gases
			18	Changing states of water
			19	Changes of states and temperature
			20	Review
Life	Plant	Plant Growth	21	Conditions of Seed Germination
			22	Conditions for Plant Growth
			23	Compare between conditions of seed Germination and plant growth
			24	How plants make their own food
			25	Review
Life	Animals	Reproduction & Heredity of Animals	26	Reproduction process in human being
			27	Reproduction process of dogs
			28	Reproduction process of birds - Chicken
			29	Reproduction process of frog
			30	Reproduction process of fish
			31	Compare The Reproductive Organs Of Humans And Birds
			32	Hereditary Characteristics Of Animals
			33	Unit Review

Content Overview

Unit	Topic	Main Topic	Lesson #	Suggested Lesson Title
Earth and Space	Space	Weather and Seasons	34	Observing clouds
			35	Types of clouds
			36	Seasons of the World
			37	Characteristics of the seasons
			38	Seasons in PNG
			39	Seasons and living things
			40	Weather seasons and Plants
			41	Weather seasons and Animals
			42	Weather seasons and the People
			43	Review
Life	Interaction & Relationship in the Environment	Energy in Food	44	Living things need food
			45	Sources of energy for living things
			46	Animals get their energy from plants
			47	Animals get energy from other animals
			48	Plants get energy from the sun.
			49	Review
Physical Science	Force and Motion	Motion and Machines	50	Balance and unbalance force
			51	Types of levers
			52	Explain pivot, load, distance in a lever
			53	Relationship between distance and force (pivot, load and distance)
			54	Using a beam balance
			55	Uses of levers in daily life
			56	Review
Earth and Space	Our Earth	Rocks, Minerals and Fossils	57	What is a rock?
			58	Sedimentary rocks
			59	Igneous rocks
			60	Metamorphic rocks
			61	Common minerals in PNG
			62	Uses of rocks and minerals
			63	What is a fossil?
			64	How are fossils formed
			65	Review
Physical Science	Energy	Heat	66	What is heat?
			67	Sources of heat
			68	What can heat can do?
			69	Heat transfer- Conduction
			70	Heat transfer- Convection
			71	Heat transfer- Radiation
			72	Uses of heat transfer
			73	Measuring and reading temperature
			74	Differentiate between heat and temperature
			75	Review

Content Overview

Unit	Topic	Main Topic	Lesson #	Suggested Lesson Title
Physical Science	Energy	Electricity 2	76	Components of a circuit
			77	Connecting in series circuit
			78	Connecting in parallel circuit
			79	Making a bulb brighter
			80	Advantages and disadvantages of parallel and series circuit
			81	Using symbols to draw circuits
			82	Uses of circuits in daily life
Physical Science	Matter	Physical and chemical changes	83	Review
			84	Properties of chemical change
			85	Observing chemical change - combustion
			86	Observing chemical change - rusting
			87	Difference between chemical and physical change
			88	Review

Content Background Information

The background information will assist teachers who are not familiar with the content of a particular unit or topic to enhance his or her planning and to teach with confidence in the classroom. As most primary teachers are generalist and not specialist in subject matter, it is important that for each unit in the syllabus, there is background content information for the teachers to use. Secondly, most Primary Schools in Papua New Guinea are situated in the remotest parts do not have other resource books, most teachers will depend on the Science Teacher Guide to develop daily teaching plan mainly in terms of content delivery to the students in the classroom.

Strand 1 : Life

Unit : Plants

Parts of a Seed

Three main parts of a seed.

Embryo - this is the tiny plant inside a plant

Food store - these are food stored by the parent plant. Also known as stored food

Seed coat - this is the hard cover around the embryo and also the food store

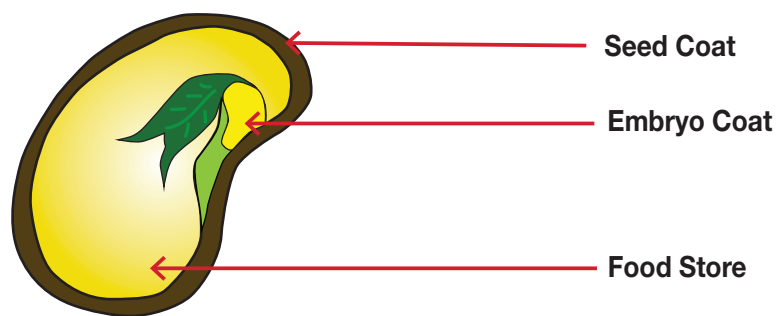

Seed germination depends on both **internal** and **external** conditions. The most important **external** factors include right temperature, water, oxygen or air and sometimes light or darkness. Various plants require different variables for successful seed germination.

- Water - allows the seed to swell up and the embryo to start growing.
- Oxygen - so that energy can be released for germination.
- Warmth - germination improves as temperature rises (up to a maximum)

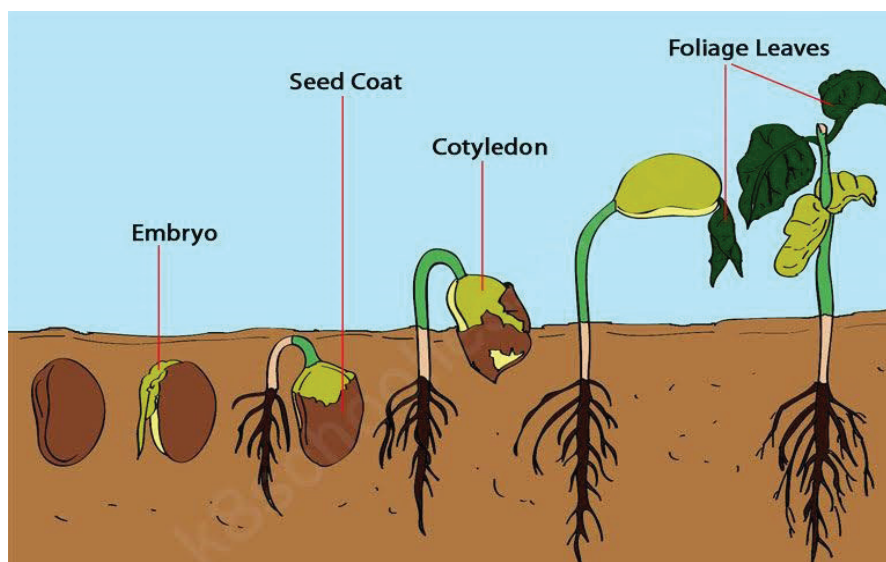

Background Information

Plant growth

Temperature. Plants grow well only within a limited temperature range. Temperatures that are too high or too low will result in abnormal development and reduced production.

Light. All vegetable plants and many flowers require large amounts of sunlight. Vegetables like those grown in a garden, need at least 8 to 10 hours of direct sunlight each day to produce well. Adequate spacing between plants will ensure that each plant receives sufficient light in the greenhouse.

Water. Providing the plants with an adequate amount of water is very important. Plants need water in order to grow.

Oxygen. Plants require oxygen for respiration to carry out their functions of water and nutrient uptake. In soil adequate oxygen is usually available, but plant roots growing in water will quickly exhaust the supply of dissolved oxygen and can be damaged or killed unless additional air is provided.

Mineral Nutrients. Green plants must absorb certain minerals through their roots to survive. In the garden these minerals are supplied by the soil and by the addition of fertilizers such as manure, compost, and fertilizer salts.

Support. In a garden the plant roots are surrounded by soil that supports the growing plant. A hydroponically grown plant must be artificially supported, usually with string or stakes.

Reproduction

The ability of living things to make or produce new living things of the same type is called Reproduction. This is something that non-livings cannot do. Beans can make new beans. Dogs can make new dogs- but stones cannot make new stones.

Asexual reproduction

Some animals can produce a new individual from part of their own body. Many plants can grow from pieces of a plant. In Papua New Guinea many food plants grown in the garden in this way. Eg Kaukau, taro, banana, pineapple and yam. All these forms of reproduction have two things in common:

- only one parent is needed.
- the new individual is the same as its parent.

Sexual reproduction

Reproduction with sex or sexual reproduction has many different forms but all of them have two things in common:

- two parents are needed: one male (or father) and one female (or mother)
- the new individual is different from either of its parents. It is a mixture of both parents.

All forms of sexual reproduction have the same four essential steps.

1. ***Production of Sex cells.*** These are made in special parts of the parents
 - the male parent makes male sex cells (called sperm in animals and pollen in flowering plants).
 - The female parent makes female sex cells (called egg cells in animals and flowering plants).
2. ***Mating*** - This is the way in which male and female sex cells are brought close to each other. The male sex cells are always the ones that move. in flowering plants mating is called **pollination**.
3. ***Fertilization*** -This is the joining together of one male sperm and one female sex cell to form a new cell called a zygote (or fertilized egg cell). Fertilization can take place either inside or outside the body of the female parent.
4. ***Development*** -This is the way in which a zygote grows and develops into a new, fully-formed individual. Development can take place either inside or outside the body of the female parent.

Background Information

Sexual Reproduction Summary

	Production of Sex Cells	Production of Sex Cells	Fertilisation	Development
Flowering Plant	Occurs in the flowers. Male sex cells (pollen) are made in the stamens. Female sex cells (egg cells) are made in the ovaries.	Called pollination. Movement of pollen from male part to female part is done by insects or wind.	Occurs inside female - (in ovary). One pollen grain joins with one egg cell in the ovary to form a zygote.	Commences inside the female part: Zygote → embryo → seed inside the ovary which becomes the fruit. Later development occurs outside when seed germinates in moist ground. Many seeds formed so that some survive.
Fish	Male: Sperm made in testes. Female: Egg cells made in ovaries.	Males and females swim close to each other. Female releases egg cells into water. Male releases sperm into water close to egg cells.	Occurs outside female's body. Sperm swim to egg cells and one sperm joins with one egg cell forming a zygote.	Occurs outside the female's body. Little or no care given by parents. Many zygote and young fish do not survive.
	Thousands of egg cells formed - few survive.			
Frog	Male: Sperm made in testes Female: Egg cells made in ovaries	Male attaches himself to the back of the female in water. Female releases egg cells into water and male deposits sperm on them at the same time.	Occurs outside female's body. Sperm push through jelly and one sperm joins with one egg cell to form a zygote.	Occurs outside the female's body. Zygote → tadpole → frog in 10 weeks. No care given by parents. Many zygotes and tadpoles do not survive.
	Hundreds of egg cells formed- few survive.			
Chicken	Male: Sperm made in testes. Female: Egg cells made in ovaries.	Rooster mates with hen and deposits sperm inside her body.	Occurs inside female's body. Sperm swim towards egg cells and one sperm joins with one egg cell to form a zygote.	Occurs outside the female's body, inside the egg (which provides food and protection for the developing embryo). Cared for and protected by mother when inside the egg and also after hatching. Most survive
	Few egg cells formed- most survive			
Pig	Male: Sperm made in testes. Female: Egg cells made in ovaries.	Male pig mates with female pig and deposits sperm inside her body.	Occurs inside female's body. Sperm swim towards egg cells and one sperm joins with one egg cell to form a zygote.	Occurs inside the female's body. Zygote → embryo → piglet inside uterus of mother. Young born fully formed. Supplied with food and cared for before and after birth. Most survive.
	Few egg cells formed- most survive.			

Background Information

Habitats

A habitat is a place that an animal lives. It provides the animal with food, water and shelter. There are many different sorts of habitats around the world from forests to grasslands and from mountain slopes to deserts. Different habitats are home to different animals.

Adaptation

An adaptation is a special skill which helps an animal to survive and do everything it needs to do. Adaptations could be physical changes to the animal's body or behavioural changes in how an individual animal or a society do things in their daily lives.

- Structural related to its physical form
- Behavioural – related to what an organism does
- Functional – related to the way it does a task

Energy in Food

The flow of energy through life is not an endless cycle. The energy doesn't go round and round getting used over and over again and never wearing out. Its passage through the food chain can better be described as in and out.

As energy moves up the food chain there is less and less of it to go around. That's the main reason there aren't very many big fierce predators compared to the herbivores. Not enough energy for them.

Most of the solar energy that falls on the earth is not used by plants. It bounces back to space or heats the air, oceans, and ground, and makes weather, among other things.

The plants only get a little bit of the solar energy that hits the earth. The herbivores only get a little bit of the energy from the plants. The **carnivores** and **decomposers** only get a little bit of the energy that was eaten by the herbivores.

(Most of the plant energy that is consumed by a herbivore is used by that herbivore to keep itself eating, breathing, walking, and staying warm. Only a little bit is left over for the carnivore or decomposer that eats the herbivore.)

We need fresh sunshine every day and new plants have to keep growing. Otherwise the whole system would quickly run out of energy and everything alive would come to a "dead" stop.

Primary Producers - Green plants and certain types of bacteria and algae are the *primary producers* because they are the ones that produce usable energy for the rest of the living organisms on earth. They use energy from the sun to make *glucose*, and other compounds that other life forms can eat and "burn" for energy.

Herbivores - Herbivores are the plant eaters. They have the ability to digest the plants they eat and release the energy stored in the plant cells for their own use. Some examples of animals in this group are deer, cows, elephants, rabbits, zebras, most insects, and birds that eat fruit and seeds. Sometimes scientists call this level of the food chain the *Primary Consumers*

Carnivores - These guys are the meat eaters. Predators and scavengers are in this group. Sometimes this level in the food chain is referred to as the *Secondary Consumers*. They eat the animals that eat the plants and sometimes they eat each other. Most of these animals can't eat plants at all. Crocodiles, sharks, killer whales, spiders, snakes, wolves, hawks, eagles and many other fierce predators are in this group.

Background Information

Decomposers - They are the guys that eat up dead bodies - both plant and animal. This group of useful critters are mostly bacteria and fungus, but also, according to our sources, includes maggots, dung beetles, earth worms, sow bugs and many other eaters of dead organic matter. Without them there would be a lot of dead bodies lying around.

They're like carnivores and herbivores, because they also have to get their energy from the cells of animals or plants. The difference is they prefer their food dead - very dead.

Background Information

Strand 2: Physical Science

Unit : Energy

Heat energy, also called *thermal energy*, is the energy an object has because of the movement of its molecules. Heat can be transferred from one object to another object. Heat energy on Earth comes from the sun.

The science of heat transfer is a broad subject which, in its most basic terms, is used to describe the transfer of heat energy from one place to another. Heat energy always moves from a higher temperature area to a lower temperature area, and the way in which this happens, along with ways to increase this effect or decrease it, is the main focus of the science of heat transfer.

The different types of heat transfer

There are three main types of heat transfer. They are conduction, convection, and radiation. The first kind (conduction) occurs when two objects of different temperature are placed in direct contact with each other. When this happens, heat energy moves out of the warmer object and into the cooler object. This occurs until both objects are at the same temperature. Example burners on stoves will conduct heat to the bottom of the pan sitting on top of it. From there the pan conducts heat to its content. It is the slowest method of heat transfer but the direct contact between the cooking surface and the item to be heated allows food to be cooked from outside in.

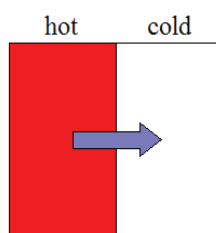
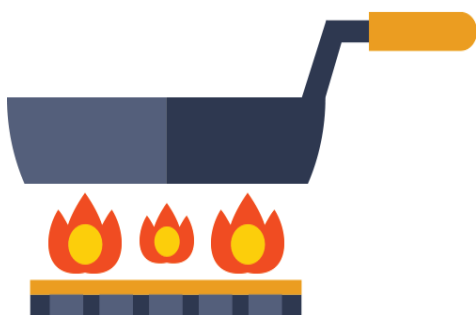

equal temperature

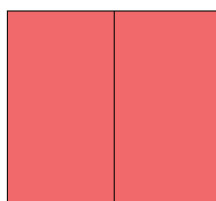

Convection

Convection occurs when warm areas of liquid or gas rise to cooler areas in the liquid or gas. Cooler liquid or gas then takes the place of the warmer areas which have risen higher. This results in a continuous circulation pattern. A good example of this is boiling water. The heat passes from the burner into the pot, heating the water at the bottom. Then this hot water rises and cooler water moves down to replace it, causing a circular motion.

Radiation

Radiation is a method of heat transfer that does not rely upon any contact between the heat source and the heated object as is the case with conduction and convection. Heat can be transmitted through empty space by thermal radiation often called *infrared radiation*. No mass is exchanged and no medium is required in the process of radiation. Examples of radiation is the heat from the sun, or heat released from the filament of a light bulb.

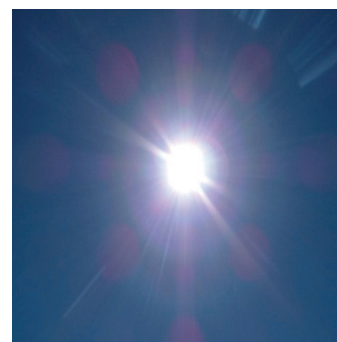

Background Information





Electricity

Electricity flows from a source like a battery along wires to a place where it is used such as bulb, then back to the battery. The electricity flows from the negative terminal of the battery, through the bulb and back to the positive terminal of the battery.

Electricity is unable to flow from the battery to the bulb if the circuit is not complete. A circuit which is not complete is called an open circuit. Switches are placed in electric circuits to control the flow of electricity.

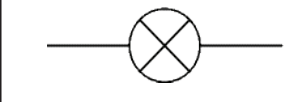
The purpose of the battery in a circuit is to give the circuit the source of energy. The purpose of a switch is to make it easy to open or close the electrical circuit, turning the flow of electricity on or off. A light bulb is used to determine whether or not the electricity is flowing. The purpose of the wire is to allow electricity to flow from one device to the next. Wire is used to carry the flow of electrons. Metal wire is very good conductor. Materials that do not allow electricity to flow through are called insulators or non- conductors.

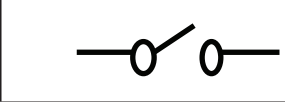
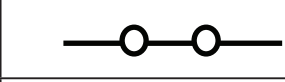
Electrical Symbols

	Bulb
	Wire
	Open switch
	Closed switch
	Cell

Background Information

Changing state of Matter

Water is a liquid at room temperature. The molecules move slowly. When heat is added to the water, the molecules gain energy and move faster and faster. When more heat is added, the liquid water will change to gas because the molecules are moving very fast and moving away from each other. The changing state of water to water vapour (gas) is called **evaporation**.

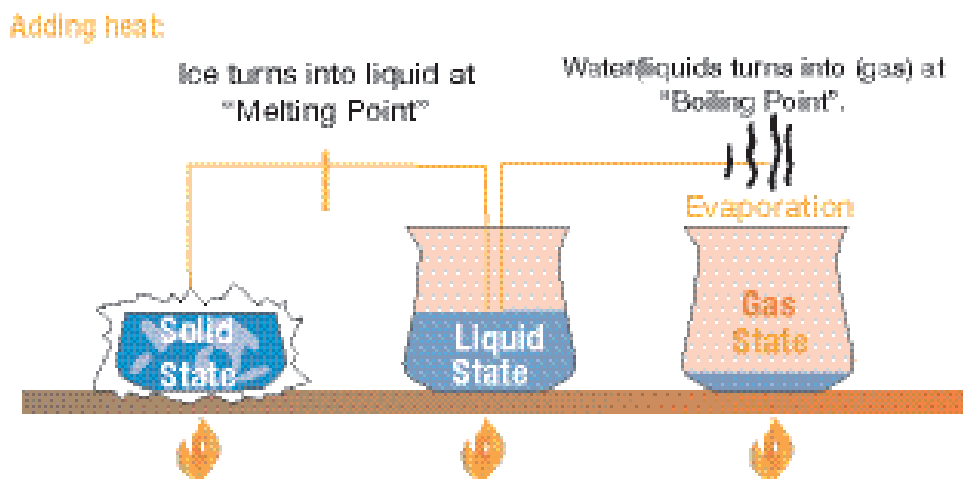

When heat is removed, temperature decreases and the molecules in the vapour slow down and gradually reduce the space between them. If more heat is removed (put in a freezer) the molecules will be very slow and move little. They will come together, turning the water into solid (ice). The point at which water turns into ice is called **Freezing point**. When ice (solid) is taken out of the freezer and placed outside, it will melt. The point at which solids melt into liquid is known as the **melting point**.

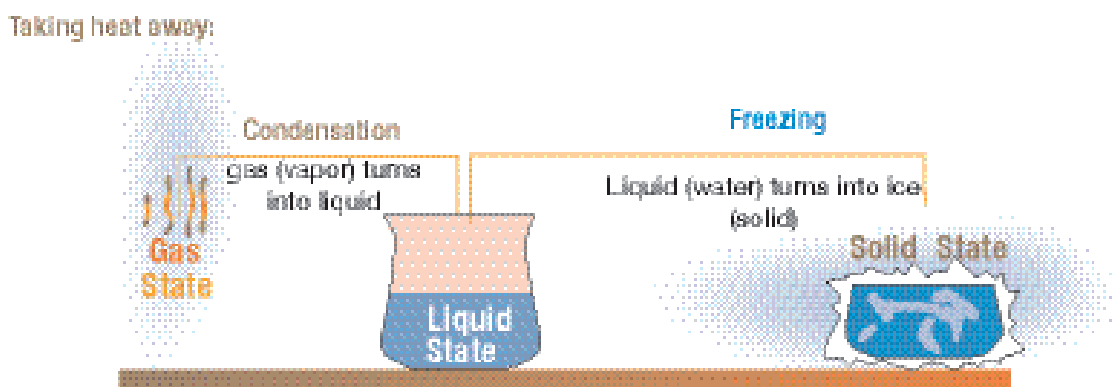

The Particle behaviours of matter in the different states

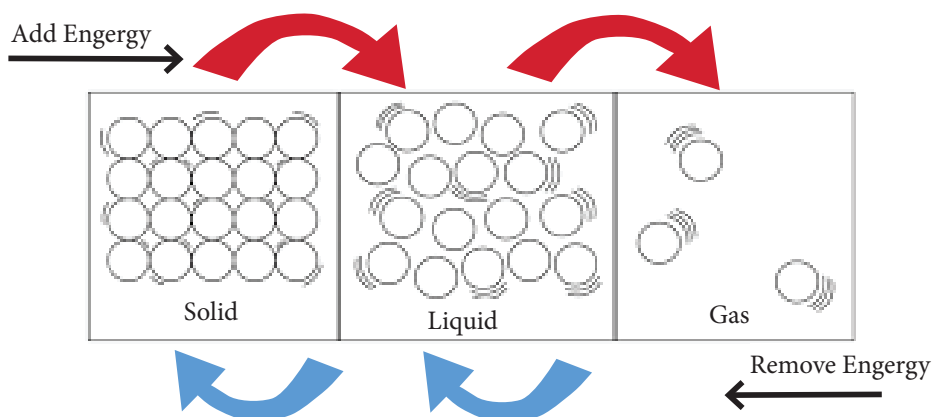

Background Information

Force and Motion

What is force? Force is defined as a push or pull on an object. A force can give energy to an object causing the object to start moving, stop moving, or change its motion. Forces occur in pairs and can be either balanced or unbalanced. Balanced forces do not cause a change in motion. They are equal in size and opposite in direction.

Gravity (the earth's pulling force) and friction (the force between two surfaces) are common forces that work against motion.

Important things about forces:

- Forces are measured in Newtons (N).
- Forces act in pairs. (balance and unbalance)
- Forces act in a particular direction.
- Forces usually cannot be seen, but their effects can be felt.

Background Information

Strand 3 : Earth and Space

Unit : Earth and Space

The six properties of rocks are:

- Luster- the state or quality of shining by reflecting light. Words used to describe luster of a rock- glitter, sparkle. Sheen, gloss
- Texture- the visual and tactile (how it feels) quality of surface. Words used to describe texture of a rock- rough, smooth, bumpy. Gritty, rigid, soft, hard
- Shape – specific form. Words- round, oval, circular, square
- Size- the dimensions, proportions – small, large, medium, tiny
- Weight – the amount of quantity of heaviness or mass. Words heavy, dense, volume.
- Colour – the quality of an object or substance with respect to light reflected off the object.

Most rocks are a solid mixture of several minerals. They are classified by how they are formed. There are three main types or classes of rocks. They are sedimentary, metamorphic and igneous rock. In each group, distinctions are made for texture or grain size and chemical or mineral content.

Sedimentary

Sedimentary rocks are formed from particles of sand, shell, pebbles and other fragments of materials. Together, all these particles are called sediment. Gradually, the sediment accumulates in layers and over a long period of time hardens into rock. Generally rock is fairly soft and may break apart or crumble easily. You can often see sand, pebbles or stones in the rock, and it is usually the only type that contains fossils.

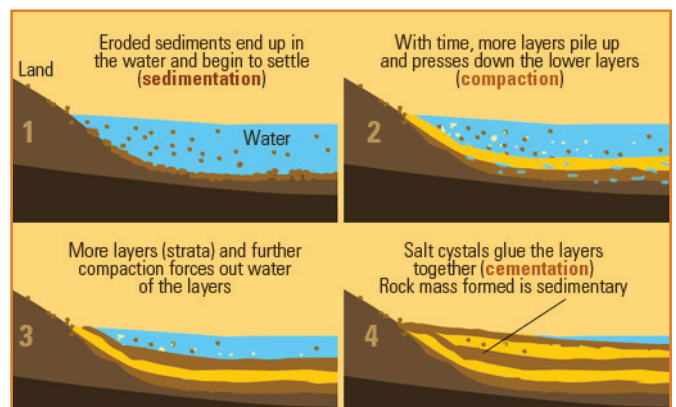

Metamorphic

Metamorphic rocks are formed under the surface of the earth from the metamorphosis (change) that occurs due to intense heat and pressure (squeezing). The rocks that result from these processes often have ribbon like layers and may have shiny crystal, formed by mineral growing slowly over time, on their surface. *Example* marble

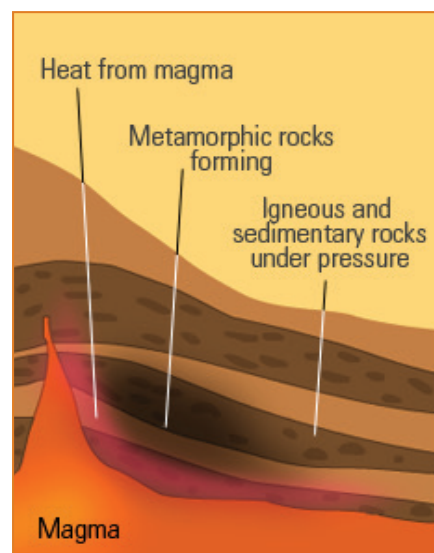

Background Information

Igneous

Igneous rocks are formed when magma (molten rock deep within the earth) cools and hardens. Sometimes the magma cools inside the earth, other times it erupts onto the surface from volcanoes (in this case, it is called lava). When lava cools very quickly, no crystals form and the rock looks shiny and glasslike. Sometimes bubbles are trapped in the rock during the cooling process, leaving tiny holes and spaces in the rock. Examples of this rock type include basalt and obsidian

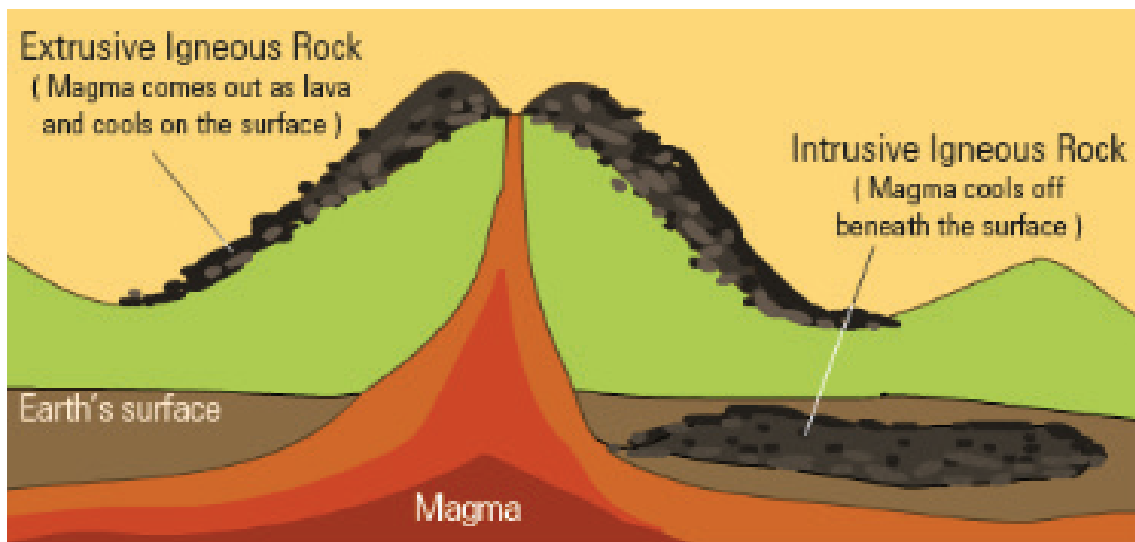

Minerals

You encounter minerals every day, from the quartz inside your watch to the gemstones you wear on your fingers. Thousands of minerals have been discovered, but only about 200 are common to the average person. People use minerals every day within their bodies and in many industries, but minerals cannot be made by man.

Occurring Naturally

- Minerals must be found occurring naturally. Substances concocted in laboratories cannot be considered minerals because they don't exist in nature.

Inorganic

- Minerals are not organic, meaning they don't belong to any class of organic compounds. Organic compounds comprise substances such as carbohydrates, proteins and fats made by living things.

Solid

- Minerals cannot be liquids or gases; they exist only as solids, a state of matter that possesses a high amount of order. Ions, charged atoms, bond together to form minerals. This formation gives minerals a solid structure. Solids have a clearly defined volume and shape, and their molecules normally cannot be compressed any further. Their structures are rigid, meaning that the particles within the mineral don't move around.

Definite Chemical Composition

- Each mineral has its own specific combination of atoms that cannot be found in any other mineral. Atoms in minerals bind together to form compounds. Salt is a mineral; it forms crystals, and these crystals contain sodium and chlorine ions bonded together in a repeating pattern. Diamonds, on the other hand, have only one type of atom: carbon; these carbon atoms come together extremely tightly

Background Information

in a type of chemical bond different from the one responsible for forming salt, making diamonds the hardest substance on Earth. Some minerals such as gold, silver, copper and diamonds have only one type of element in them

Crystalline Structure

- Minerals have crystals that contain repeated arrangements of atoms or ions; each repeating part of a crystal is a unit cell. The unit cell can have different shapes because of the size of the ion or atom and how it attracts other particles. Crystals usually take one of six common shapes, including cubic and prism forms, although other forms exist less commonly. Minerals have crystalline structures that are formed in two ways. Magma or lava, the hot, molten rock that comes from volcanoes, can become crystallized to form minerals. Minerals crystallize also by the action of water when oceans or seas deposit substances dissolved in them in a certain area; when the water has evaporated, crystals appear.

Weather

The hotness or coldness of a substance is called its temperature and is measured with a thermometer. The ordinary thermometer consists of a hollow glass bulb attached to a narrow stem with a thread-like bore. It contains liquid such as alcohol and mercury. When air around the tube heats the liquid, the liquid expands and moves up the tube. A scale then shows what the actual temperature is.

A *rain gauge* measures the amount of rain that has fallen over a specific time period. It is measured in centimetres.

A *wind vane* is an instrument that determines the direction from which the wind is blowing. An anemometer measures wind speed. The cup catches the wind, turning a dial attached to the instrument. The dial shows the wind speed.

A *barometer* measures air pressure. It tells you whether or not the pressure is rising or falling. A rising barometer means sunny and dry conditions, while a falling barometer means stormy and wet conditions. An Italian scientist named *Torricelli* built the first barometer in 1643.



Thermometer



Rain gauge



Wind vane



Anemometer



Anemometer

Background Information

The four Seasons

The cycle of the seasons is caused by the Earth's tilt toward the sun. The planet rotates around an (invisible) axis. At different times of the year, the northern and southern axis is closer to the sun. At these times the hemisphere tipped towards the sun experiences summer while the hemisphere tilted away from the sun experiences winter.

In the **spring**, seeds take root and vegetation begins to grow. The weather is warmer and often wetter. Animals wake or return from warmer climates, often with new births. Melting snow from the previous season along with increased rainfall, can cause flooding.

In the **summer**, temperatures may increase to their hottest of the year. If they spike too high, heat waves or drought may cause trouble for people, animals and plants. Rainfall may increase in some areas, as well. Others may receive less water and forest fires may become more frequent.

In **autumn**, or fall, temperatures cool again. Plants may begin to grow dormant. Animals might prepare themselves for the upcoming weather, storing food or travelling to warmer regions.

Winter often brings chill. Some areas may experience snow, ice, while others see only cold rain. Animals find ways to warm themselves and may have changed their appearance to adapt.

Areas at the **equator** experience a different seasonal variation, marked by a prolonged **wet** season during December through to March, and a **dry season** that lasts from April to December. This yearly balance of wet and dry is essential for the ecology of equatorial regions.

Clouds

The names of the clouds often tell us what kinds of clouds they are and the altitudes that they are located in the atmosphere. Many of them have Latin names.

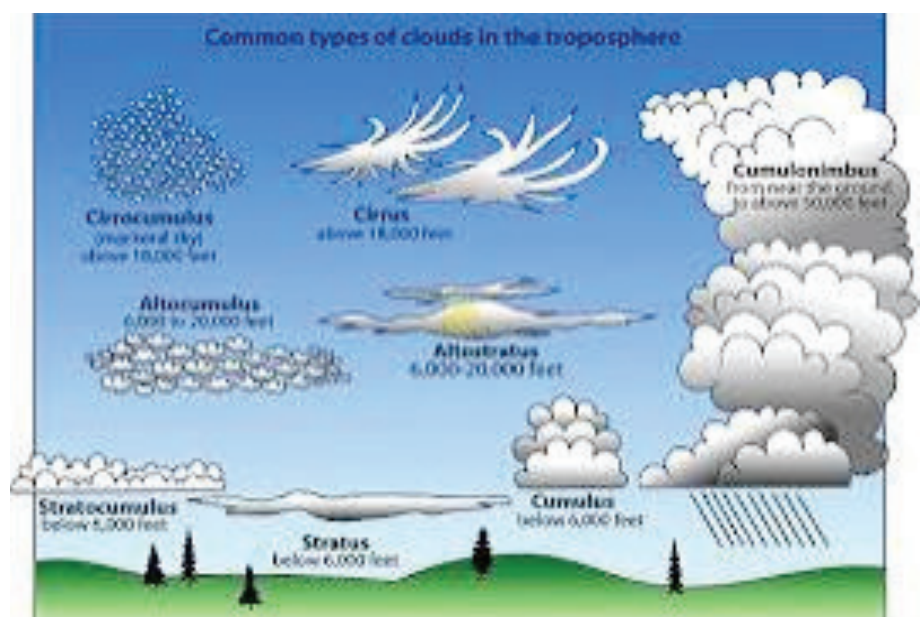

Water droplets in the atmosphere reflect sunlight. When there is less water vapour, less light is reflected and therefore, more light passes through to illuminate the bottom of the cloud. When a cloud is heavily laden with water particles, all the light is reflected (or scattered) and no light is able to pass through. From the ground, looking up, it looks very dark because there is no light passing through. As clouds become taller, the darker the base becomes.

Clouds are a vital part of the water cycle. This is because they make up the moisture that ends up as rain (precipitation) and keeps the cycle going.

Strand 1: Life

Unit 1 : Plants



Lesson title: Conditions of seed germination

Content standard: 5.1.1 Investigate and understand the conditions necessary for seed germination and plant growth.

Objective: By the end of the lesson the students can be able to identify different conditions which helps a seed to germinate.

Key concepts:

- Seeds need the right temperature, water and oxygen in order to germinate.

Skills, attitudes and values:

Knowledge	Skills	Attitudes
<ul style="list-style-type: none"> • Seeds germinates under certain conditions. • There are three stages of seed germination. (insert the stages in the teachers information) 	<ul style="list-style-type: none"> • Identify conditions suitable for seed germination. • Draw the stages of seed germination. 	<ul style="list-style-type: none"> • Participate actively in activity. • Listening attentively.

Materials: Bean seeds for each child, a poster or chart showing an illustration on the stages of seed germination, soil, tins, water.



- Be careful when handling sharp objects.
- Report any accidents to the class teacher.

Teacher's Notes :

This lesson will require students to bring in materials before the activity. For uniformity purposes, ask the students to bring seeds of a common plant in the area. Peanut seeds and beans seeds would be very ideal for this lesson.

For the collection of soil, inform students to bring in tins or plastic containers. This will allow for holes to be created n this tins and plastic containers. It is also advisable that you identify the place to collect soil and have the soil in ready before the lesson to save time.

How a seed germinates

Seeds do not need soil to grow. They will grow if they have water and warmth. When a seeds first starts to grow the water causes the seed to swell and the tiny plant inside the seed pushes its way out of its covering. At first the tiny plant uses the stored food within the seed. When the stored food is gone or used up the tiny plant must get food from the soil, air water and sunlight to continue to live and grow.



A : Guided Lessons

Teaching and learning

Key Question: What conditions are suitable for seed germination?

Activity 1: Planting Seeds.

- Use the tin to collect some fertile soil from their school garden.
- Carefully place the seeds into the tin.
- Add water to the seeds and place somewhere in the classroom where there is enough sunlight.

Activity 2

List down three important conditions needed for plant germination.

- _____
- _____
- _____

Discussion

What will happen if one of the condition is not met?

Summary



- Seed germination depends on both internal and external conditions.
- The most important external factors include right temperature, water, oxygen or air.

Blackboard Plan

Title: Conditions of Seed germination



Key Question: What conditions are suitable for seed germination?

Activity

Activity 1: Planting Seeds

- Use the tin to collect some fertile soil from their school garden.
- Carefully place the seeds into the tin.
- Add water to the seeds and place somewhere in the classroom where there is enough sunlight.

Activity 2

List down three important conditions needed for plant germination.

- _____
- _____
- _____

Discussion

What will happen if one of the condition is not met?

- Summary Seed germination depends on both internal and external conditions.
- The most important external factors include right temperature, water, oxygen or air.

A : Guided Lessons

Introduction:

- Ask the children to discuss how plants start growing.
- Introduce the topic of the lessons and the materials needed for the lesson.

Body:

Teacher activities

- Display pictures of seed germination.
- Explain the conditions needed for seed germination.
- Explain the activity to the students. Tell the students that they are going to keep a record of the plant growth. Emphasize on the safety rules.
- For home work, complete activity 2.

Student activities

- Listen and discuss how plants grow.
- Listen attentively to the explanations.
- Participate and follow instructions to complete given activities.
- Ensure that safety rules are followed.
- Work cooperatively, appreciate and have respect for others.

Conclusion:

- Teacher summarize the lesson by asking questions to students or what the students have learnt in the lesson.

Questions

- 1) What do seeds need in order to germinate?
- 2) Where does the seed get the food from before it germinates?
- 3) What happens to the seed if one of the conditions is not right?

Evaluation:

Was the organisation of the activity done well? Were my instructions clear and easy to follow? Have the students understood the concept of seed germination?

A : Guided Lessons - Sample 2

Lesson No.75

Strand 2: Physical Science

Unit 1: Energy

Lesson title: Components of circuits



Content standard: 5.2.2 Investigate and identify the properties of electric circuits.

Objective: By the end of the lesson students can be able to:

- identify, name and describe the components of a circuit
- explain the function of each component.

Key concepts:

- Electricity flows from place to place along paths called a circuit.

Knowledge	Skills	Attitudes
The four main components of a circuit the battery, wire, switch and lamp/or bulb.	Draw and label the components of circuits.	Appreciate each component play an important role in a circuit.

Materials:

Wire, switch, battery and bulb/ lamp

Teacher's Notes:

Electricity flows from place to place along paths. These paths are called the circuits. A circuit is a kind of path that begins and ends in the same place. An electric circuit has four main components. They are:

- Battery
- Wire
- Switch
- Lamp/blub.

The purpose of the battery in a circuit is to give the circuit the source of energy. The purpose of a switch is to make it easy to open or close the electrical circuit, turning the flow of electricity on or off. A light bulb is used to determine whether or not the electricity is flowing. The purpose of the wire is to allow electricity to flow from one device to the next. Wire is used to carry the flow of electrons. Metal wire is very good conductor. Materials that do not allow electricity to flow through are called insulators or non- conductors.

Teaching and learning

Key Question “What are the components of a circuit?”

Activity 1: Making a circuit

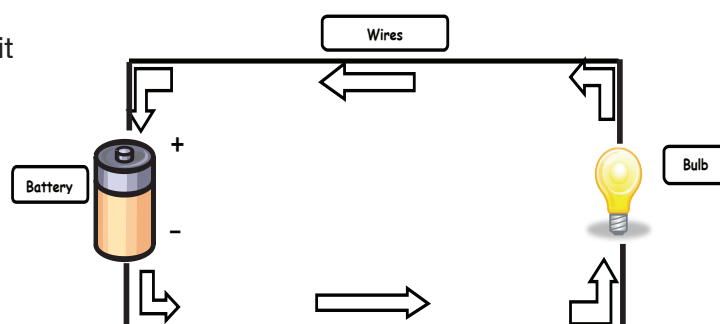

A : Guided Lessons

Activity 2:

- Draw the components of a circuit.
- Label the components of a circuit.
- Complete the following table.



Component of the Circuit	Function
1. Battery 2. Wire 3. Bulb 4. Switch	

Discussion

After drawing, labelling and describing the role of a circuit.

1. Why are these components important in a circuit?
2. Which of these components store energy?

Summary



- All the components have a role to play in order for the circuit to function.

Blackboard Plan

Title: Components of a Circuit

Key Question: What are the components of a circuit?

Activity

Activity 1: Refer to diagram above and draw on the board

Activity 2

- Draw the components of a circuit.
- Label the components of a circuit
- Complete the following table.

Component of the Circuit	Function
1. Battery 2. Wire 3. Bulb 4. Switch	

Discussion

1. Why are these components important in a circuit?
Which of these components
2. Which of these components store energy?

SUMMARY

- All the components have a role to play in order for the circuit to function.

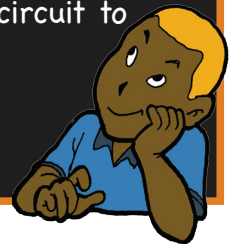

A : Guided Lessons

Introduction:

- Recap the lesson by asking questions from the previous lesson.
- Introduce the topic of the lessons and the materials needed for the lesson.

Body:

Teacher activities

- Ask students to discuss how a torch works.
- Explain the components of a circuit to the students. (refer to teachers notes)
- Guide and supervise students during the course of the activity.
- Emphasise safety rules.

Student activities

- Participate in the discussion activity.
- Listen attentively and take notes.
- Collect the materials and carry out the experiment. Ensure that safety rules are followed.
- Participate in the discussion.

Conclusion:

- Summarize the lesson by asking questions to the students.

Questions

- 1) Name the components of a simple circuit. (*Wire, battery, bulb, switch*)
 - 2) Which component of all components is very important? (*None. All components are important*)
- Emphasize key learning points
All the components have a role to play in order for the circuit to function.

Evaluation:

Have I provided enough material for the activity? Were my instructions clear? Have the students identified the components of a circuit? Have I emphasized enough on the safety while doing the activity?

A : Guided Lessons -Sample 3

Lesson No.50

Strand 2: Physical Science

Unit 2 : Force & Motion



Lesson title: Balanced and unbalanced force

Content standard: 5.2.3 Investigate and explain changes in motion of objects and the regularity of levers.

Objective: By the end of this lesson the students can be able to:

- identify and explain balance and unbalance force
- demonstrate and explain balance and unbalance force.

Key concepts:

- A force can give energy to an object causing the object to start moving, stop moving, or change its motion.
- Forces occur in pairs and can be either balanced or unbalanced.
- Balanced forces do not cause a change in motion.

Knowledge	Skills	Attitudes
<ul style="list-style-type: none">• A balanced force is when the same amount of force is applied on both sides.• An unbalanced force is when more force is applied on one side.	Demonstrate unbalance and balance force.	Willingness to take part in the activity.

Materials: 10m rope, rag



- Ensure to have light stretches before the fun filled activity.
- Ensure that the rope is strong enough to withstand the forces of both teams.

Teacher's Notes:

Force is a push or pull. It can make things move. Some forces are balanced while others unbalanced. Balanced forces are when equal forces are applied on both sides of an object. Unbalanced forces are when different amounts of forces are applied on both side.

The activity that follow should be carried out on the playing field, or other large area. Ensure that all materials are prepared the area of the activity is safe before the actual lesson is conducted.

A : Guided Lessons

Teaching and learning

Key Question: What will happen if the force is not balanced

Activity 1: Tug of War Game

- Select two teams that are equal in number but unequal in strength.
- Make a mark on the ground and tie a rag on the rope. (Half mark)
- Line the teams along the rope. Students should be encouraged to stand on both side to lessen the tendency to swing when students start to pull.
- The teacher should give this directions.
 - pick up the rope (do not pull until you are told to do so)
 - take your stands
 - pull !
- Observe what happens.
- Repeat the experiment using two different with teams of unequal strength.

Note: The rag will move in the direction of the larger force.

Activity 2:

- Define the words balance force and unbalance force.
- Complete the table by writing examples of each under the correct heading.

Balance Force	Unbalanced force
e.g. Sitting on a chair	e.g. Batting a ball

Summary



- Unbalanced force (unequal) forces produce movement. (of the rag and rope)
- If there is two balanced (equal and opposite) forces, there will be no motion.

Title: Balanced and Unbalanced Force

Key Question: What will happen if there is an unbalance force?

Activity 1: Tug of War Game

Activity 2:

- Define the words balance force and unbalance force
- Complete the table by writing examples of each under the correct heading

Discussion

- Why are these components import in a circuit?
Which of this components
- Which of this components store energy?

SUMMARY

- Unbalanced force (unequal) forces produce mo ment (of the rag and rope)
- If there is two balanced (equal and opposite) forces, there will be no motion.



A : Guided Lessons

Introduction:

- Teacher ask students to discuss and brainstorm the definition of force.
- Demonstrates to the students the definition by pulling and pushing an object.
- Introduce the lesson title and object for the lesson.

Body:

Teacher activities

- Teacher asks the question “What is an unbalanced force?”
- Explain to the students that they are going to play a game and they have to come with a definition after the game is over. Organize the class into groups.
- Go through the safety rules with the class.
- Guide and supervisor students during the course of the game.

Student activities

- Participate by providing answers to the teacher.
- Listen attentively and follow teachers directions.
- Get into groups and wait for the next instruction.
- Discuss the meaning of balanced and unbalanced force.
- Record their findings and write their conclusions, then report or present their findings.

Conclusion

- Teacher summarize the lesson by asking questions to students or what the students have learnt in the lesson.
- Students and teacher display circuits and tidy up.

Evaluation:

Have I delivered the concept of unbalance and balance force well? Have the students really understood the concept in the small activity? Are they now able to distinguish between balance and unbalance forces ?

Strand 3: Earth and Space

Unit 1 : Our Earth



Lesson title: Balanced and Unbalanced force

Content standard: 5.3.1 Investigate the characteristics and properties of rocks and minerals.

Objective: By the end of the lesson students can be able to describe and explain the process involved in the formation of sedimentary rocks.

Key concept

- There are three main types or classes of rocks- sedimentary, igneous and metamorphic.
- Sedimentary rocks are formed from sediments that settle over a period of time.

Knowledge	Skills	Attitudes
Sedimentary rocks are formed from particles of sand, shell, pebbles and other fragments of materials.	Identify and describe the process of sedimentation.	Appreciate that sedimentary rocks are formed from sediments.

Materials: buckets of sand, sandstone, gravel, water, big bucket/container.



- Ensure that apparatus are handled well during the experiment.
- Do not play with stones.

Teacher's Notes :

The lesson should be conducted with hands-on materials. It is recommended that a mixture of different soil types be made available before the experiment. If the materials are not sufficient enough, you can do the demonstration for the students to see. Give them enough time to ask questions.

The main concept behind this experiment is to understand the process involved in the formation of sedimentary rocks.

Tiny debris (also known as sediments) from eroded mountains and rock masses together with the sand and other particles are often washed down the slopes of highlands into water bodies. Sediments are often rounded or smoothed by the abrasion it undergoes as it moved with water and other sediments. The sediments slowly settle under the water in a process called **sedimentation**.

As the years go by, layers of sediments that have settled under the ocean or water bodies, harden under the weight of the topmost layers and water. This process is known as **compaction**. Sometimes organic matter and fossils settle in them too and are compressed together with the sediments. Compaction leads to **cementation** which is the gluing or cementing of pieces of rocks together by salt compounds. When these harden, they form the sedimentary rocks.

A : Guided Lessons

During the formation of sedimentary rocks, massive amounts of vegetative and animal residue may be trapped in the layers. They go on to form carbon pockets in these rocks, which humans extract later on in the form of crude oil. Note that the formation of coals takes millions of years.

Sedimentary rocks appear in layers called **strata**. The oldest rocks tend to be at the bottom with newer rocks above them. Examples of sedimentary rocks are, sandstone, limestone and conglomerate.

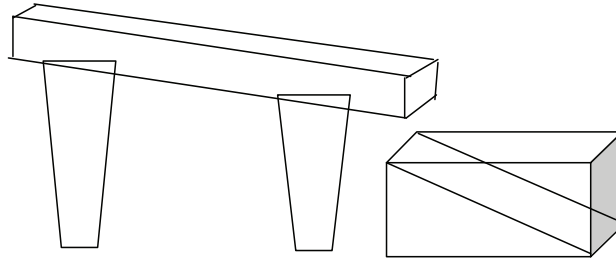

Activity

1. Set up the equipment as shown above.
2. Pour the sand, sandstone and gravel on the trough/ gutter. Mix them.
3. Pour water on the trough until all the sand, sandstone, and gravel have gone.
4. Observe carefully what happens.

Discussion: How does sedimentary rock form?

Title: Sedimentary Rock

Key Question: How is sedimentary rock formed?

Activity 1 (Refer to the diagram above).

1. Set up the equipment as shown above
2. Pour the sand, sandstone and gravel on the trough/ gutter. Mix them
3. Pour water on the trough until all the sand, sandstone, and gravel have gone.
4. Observe carefully what happens

Discussion

How long does it sedimentary rocks to form?

SUMMARY

Sedimentary rock is a type of rock that is formed by sediments in a process called **sedimentation**

A : Guided Lessons

Introduction:

- Teacher ask students “What are rocks made of?”
- Teacher introduce the topic and lesson objective

Body:

Teacher activities

- Explain the formation of sedimentary rocks (refer to teachers notes)
- Explain the activity to the students. Emphasize safety rules
- Perform the experiment in front of the class (students to assist where necessary)
- Facilitate discussion

Student activities

- Provide answers to questions.
- Listen attentively and take notes.
- Participate and follow instructions to complete given activities.
- Students discuss in groups by drawing a flow chart to identify the effects of weather on human activities.

Conclusion:

- Teacher summarize the lesson by asking questions to students or what the students have learnt in the lesson.
- Students and teacher display flow charts.

Evaluation:

Have I provided a good set of guided questions? Were my instructions clear? Have the students really understood the concept of sedimentary formation?

A : Guided Lessons

Lesson No.1

Strand 1 : Life

Unit 4: Interaction and relationship in the environment.



Lesson title: What is a Habitat?

Content standard: 5.1.4 Investigate the adaptation of different living things in different habitats.

Objective: By the end of the lesson the students can be able to:

- explain what a habitat is
- identify various habitats around the school.

Key concept

- There are many different sorts of habitats around the world from forests to grasslands and from mountain slopes to the ocean shores.
- Different habitats are home to different living things.

Knowledge, Skills, Attitudes and values (KSAV)

Knowledge	Skills	Attitudes
<ul style="list-style-type: none">• A habitat is a place that a living organism lives in.• A habitat provides to the living organism food, water and shelter.	<ul style="list-style-type: none">• Explain and can identify what a habitat is.• Observe and identify different habitat around their classroom.	<ul style="list-style-type: none">• Value different habitat and organisms that live in them.• Appreciate different organisms in their habitat.

Materials: Chart showing various habitats



- Be careful when going outside of your classrooms to locate a habitat.
- Be careful not to disturb insects, plants, animals and other living while observing the habitat.

Teacher's Notes:

All living things such as animals, plants and other living organisms live in a certain place or area they find comfortable. This place or area is called habitat. Habitats can be on top of a tree, in the ground, on the land or in the water or sea. Organisms living in that habitat can depend on non-living things such as water, soil, mineral and temperature and as well as animals and plants for their own survival.

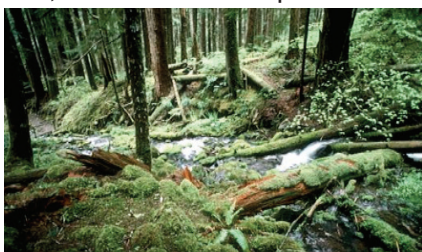

Activity

- Define what a habitat is?
- Name three different habitats and the type of animals that live in it.

Summary



- A habitat is a place that a living organism lives in.
- A habitat provides to the living organism food, water and shelter.

Strand 1: Life

Unit 4: Interaction and relationship in the environment.



Lesson title: Different types of habitat – Seashore

Content standard: 5.1.4 Investigate the adaptation of different living things in different habitats.

Objective: By the end of the lesson students can be able to:

- define what a rainforest is.
- explain that rainforest is one of habitats for living things.

Key concept

- There are many different types of habitats around the world from forests to grasslands and from mountain slopes to the ocean shores.
- Different habitats are home to different living things.

Knowledge, Skills, Attitudes and values (KSAV)

Knowledge	Skills	Attitudes
Seashore is one of the very important habitats that living things like fish and many other living and non- living things live in.	<ul style="list-style-type: none"> • Identify and describe plants and animals that live in the seashore community. 	<ul style="list-style-type: none"> • Appreciate and care for the animals that live in the seashore.

Materials: Picture Books (on ocean and its marine life).

Teacher’s Notes:

The seashore community has a variety of plants and animals that live in the sea or on the land near the sea. It provides an excellent environment for people to live in. There are plants and animals available for food and materials needed to build shelter and other things necessary for people to live. Many different kinds of animals live at the seashore. Some are so small that they can’t be seen with a microscope. These microscopic animals are very important food for the larger animals that live in the sea. The seashore community also has a large number of plants. Palm trees like the coconut palms can be found growing along the beaches. There are many microscopic plants that live in the sea. These microscopic plants are rich source of food for animals. The seashore also has many different types of seaweed. These seaweeds provide shelter and food to the animals of the seashore.

Teaching and Learning activities

Activity 1: Designing a poster

A very important seashore community animal in PNG is the dugong or sometimes referred to as the “sea cow”. The dugong is a large mammal that feeds on underwater plants. The dugong is an endangered animal and is a protected animal in PNG. Talk to the children about the dugong and other endangered animals and why it is important to protect them.

Summary



- Seashore is one of the very important habitats that living things like fish and many other living and non- living things live in.
- The seashore community has a variety of plants and animals that live in the sea or on the land near the sea. It also provides an excellent environment for people to live in.

Strand 1 : Life

Unit 4: Interaction and Relationship in the Environment

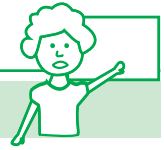

Lesson title: Different types of habitat – Rainforest

Content standard: 5.1.4 Investigate the adaptation of different living things in different habitats.

Objective: By the end of the lesson students can be able to:

- define what a rainforest is
- explain that rainforest is one of habitats for living things.

Knowledge, skills, attitudes and values:

Knowledge	Skills	Attitudes
A rainforest is a place where there is thick dense forest found in and places of high rain fall.	Use atlas or map and locate some rainforests of Papua New Guinea.	Respect the environment by not burning grasses.

Materials: Papua New Guinea Atlas, Picture Books (on forest/rainforest).

Teacher's Notes:

Rainforest have the most kinds of plants and animals in the world, especially plants. Trees in the rainforests can be very tall and can form a cover over the plants below. This cover protects the soil of the rainforests from the strong forces of the tropical rains. Many people think that the rich plant life of the rainforest means that the soil is very rich. This is not the case and the soils are often very poor. It is not the soil that contains the minerals of the rainforest, but the plants.

The rainforests of PNG do not have the variety of animals found in other rainforests of the world. They do, however, have many different kinds of animals- birds, like the bird of paradise and the cassowary, many insects like the birdwing butterfly, climbing animals like the cuscus and the tree kangaroo and many kinds of reptiles including python and the crocodile.

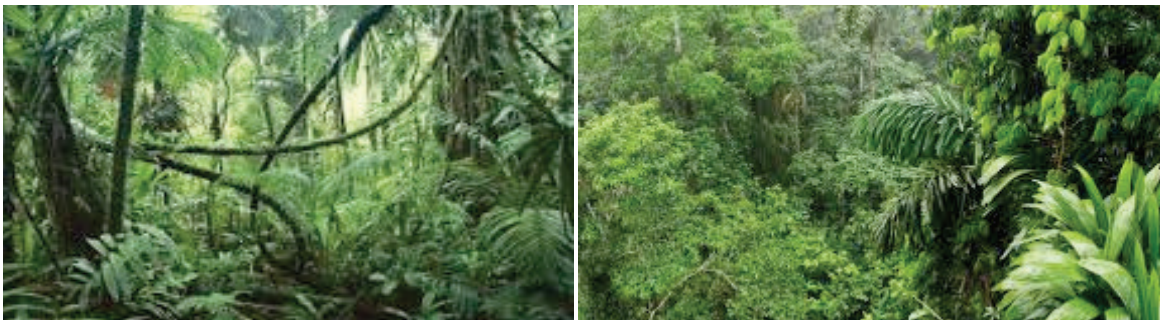

Teaching and learning activities

Activity 1

- List at least three animals that can be found in the grassland.
- Name the two different types of grassland.

Summary



- A rainforest is a place where there is thick dense forest found and place of high rainfall.
- Rainforests have a variety of plants and animals including insects.

Strand 1 : Life

Unit 4 : Interaction and Relationship in the Environment



Lesson title: Different types of habitat – Grassland

Content standard: 5.1.4 Investigate the adaptation of different living things in different habitats.

Objective: By the end of the lesson students can be able to:

- explain that grassland is a habitat found in tropical areas
- identify that living things that live in grassland interact with each other for survival.

Knowledge, skills, attitudes and values:

Knowledge	Skills	Attitudes
<ul style="list-style-type: none"> • Grassland can be found in many parts of the world. It stretches between forests and ends at the deserts. • Grassland provides good hunting ground for humans. 	<ul style="list-style-type: none"> • Identify and list animals that live in grassland. 	<ul style="list-style-type: none"> • Respect the environment by not burning grasses.

Materials: Grassland chart, Picture of animals from grassland

Teacher's Notes:

Large area of Papua New Guinea is covered by grassland. There are over 300 different kinds of grasses that grow in the grassland. The grassland have trees and are usually hot and dry. The grassland can be divided into two groups, natural grassland and those caused by people. Much of the grassland in PNG have been caused by people. It has developed as a result of people clearing forest areas for different reasons such as for growing food, protection, hunting and gathering materials for building houses and fences.



Teaching and learning activities

Activity 1

- List at least three animals that can be found in the grassland.
- Name the two different types of grassland.

Summary



- Grassland can be found in many parts of the world. It provides a home for grassland animals.
- Grassland provides good hunting ground for humans.

A : Guided Lessons

Lesson No.6

Strand 1: Life

Unit 4 : Interaction and Relationship in the Environment



Lesson title: What is adaptation?

Content standard: 5.1.4 Investigate the adaptation of different living things in different habitats.

Objective: By the end of the lesson students can be able to:

- define what is adaptation
- explain adaptation in relation to habitation.

Key concept

- Adaptation of living things happens when animals, plants and other living things get to adjust to the way they lived in the past habitat to the new habitat for their survival.

Knowledge, skills, attitudes and values:

Knowledge	Skills	Attitudes
Organisms have different adaptations because they live in different environment.	Describe different ways in which animals use in order to survive.	Accept and appreciate that living adjust to new environments in order to survive.

Materials: Charts of animals that camouflage in the environment Text books, syllabus

Teacher's Notes:

Adaptation is referred to when living things such as animals, insects and plants manage to survive in a habitat.

Importance of adaptation.

- Adaptation allows animals to adjust themselves and survive in their natural environment.
- Adaptations help animals to maximise their species survival in their environmental habitat.
- Adaptation assist animals to move, survive from predators, catch prey or find food, find mate and eat.
- Successful adaptation allow animals to live and survive long enough to reproduce and produce offspring.

Adaptation can be behavioural or physical.

Animals have special features, or physical adaptations that make themselves survive in a habitat. For example, the inserted pictures have animals **camouflaged** themselves. They have features that blend themselves to their environment or habitat so that to protect themselves from predators.



A : Guided Lessons

Summary



- Adaptation refers to the ability of living things to adjust to different conditions within their environments.
- A physical adaptation is some type of structural modification made to a part of the body. It includes teeth, body coverings and movement.
- A behavioural adaptation is something an animal does, how it acts usually in response to some type of external stimulus.

Strand 1 : Life

Unit 4: Interaction and Relationship in the Environment



Lesson title: Adaptation of plants in different habitats

Content standard: 5.1.4 Investigate the adaptation of different living things in different habitats.

Objective: By the end of the lesson the students will be able to:

- describe how plants can be able to adapt to different habitats.
- give some examples of plants that adapt to different kinds of habitat.

Key Concepts:

- Different plants adapt to different habitats easily.

Knowledge, skills, attitudes and values:

Knowledge	Skills	Attitudes
<ul style="list-style-type: none">• In order for plants to survive in a habitat, they need to adapt to the surroundings and climate.	<ul style="list-style-type: none">• Discuss how plants in their environment can adopt to their habitat.• Identify plants or trees that can survive extreme weather conditions in their area.	<ul style="list-style-type: none">• Respect and care for plants.

Materials: A3 papers, pencils, colour pencils.

Teacher's Notes :

Plants adapt or adjust to their surroundings. This helps them to live and grow. A particular place or a specific habitat calls for specific conditions and adapting to such conditions helps the plants to survive. This is the reason why certain plants are found in certain areas.

A tree that lives in the rainforest would not survive in a desert. A cactus that lives in the desert will not survive in a water lily pad. Therefore plants adapt to their surroundings and climates. If the habitat changes drastically the plant species must adapt, otherwise they will not survive.

Teaching and Learning Activity

Summary

- Plants adjust to their surroundings very easily.

Strand 2: Physical Science

Unit 3: Matter

Lesson title: Properties of solid



Content standard: 5.2.4 Investigate the relationship between the three states of matter and heat.

Objective: By the end of the lesson students can be able to identify the characteristics of solid.

Key Concepts

- Solids are materials that have definite shapes. They can be soft or hard.
- Solids have weight and take up space.

Knowledge	Skills	Attitudes
<ul style="list-style-type: none"> • Solids can be described based on the properties. • Properties of solids include the shape, size texture, colour, smell and the sound that it can make. • Particles in solids are tightly packed. 	<ul style="list-style-type: none"> • Use the five senses to identify properties of solids. • Classify solids according to different properties. • Identify solids that have definite shape and those that change their shape. 	<p>Accept and appreciate that solids have various properties that can be used to classify them.</p>

Materials: Various sample of solids each with a distinct property.

Teacher's Notes:

The world around us is made up of many different materials. These materials can be described according to certain properties. We describe the materials and objects in terms of properties such as shape, texture, colour, smell and sound. We use our senses to identify the properties. All materials and objects take up space and have weight.

All materials and objects of the world have been grouped into three groups; **solids, liquids and gas**. These groups are also known as the **states of matter**. The word state means “the conditions of “and the word matter means “material or object”.

Solid materials have certain conditions that make them solid. They have definite shape. Many solids have a shape that is firm and not easily changed. Some solids have shapes that are easily changed. Ice is a good example of a solid that changes shape when it is heated. Candle wax is another solid that changes when it is heated. Solids like salt and sugar can change shape when they are put in water. Ashes are also solids. They have tiny solid particles that fall off when something burns.

It is very hard to change shapes of other solids like, iron or steel. Solids can be soft or hard. They can have smell or while others don't. All solids have weight and take up space.

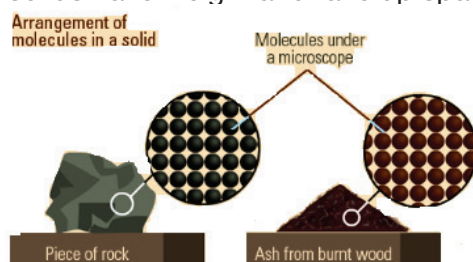

A : Guided Lessons

Teaching and Learning

Activity:

1. Get the students to go outside and collect 10 things that are solids

1.	6.
2.	7.
3.	8.
4.	9.
5.	10.

2. Classify / or group the solids based on a particular property- colour, size, weight etc. (teacher to check and confirm)

Summary



- Many solids have a shape that is definite while some solids have shapes that are easily changed.
- All solids have weight and take up space.

Strand 2 : Physical Science

Unit 3: Matter



Lesson title: Properties of liquid

Content standard: 5.2.4 Investigate the relationship between the three states of matter and heat.

Objective: By the end of the lesson the students can be able to identify the different properties of liquid.

Key Concepts:

- Liquid materials do not have shape. They take up the shape of the container

Knowledge, skills, attitudes and values:

Knowledge	Skills	Attitudes
<ul style="list-style-type: none"> • Liquids take the shape of the container when poured. • Liquids change when heat is added or removed. • Particles in liquids close to each other but are not tightly packed. 	<ul style="list-style-type: none"> • Identify the properties of liquid. • Model the particles in liquids. 	Accept and appreciate that liquids do not have a definite shape.

Materials: variety of containers or jars, cordial (raspberry), water

Teacher's Notes :

Liquid materials do not have shape. They take up the shape of the container that they are placed in. Most liquids can be poured from container to container. Most liquids change when they are heated or cooled. When ice is heated, it changes from solid to liquid water. If we cool the liquid (water) enough it will freeze back to solid (ice).

The activity below will require different sizes of containers and jars. The teacher should ask the students to bring in variety of containers. The main idea here is to emphasize the point that liquid take the shape of the container. Other than just saying it, students must have a feel of it.

Teaching and Learning Activities

Activity 1: Let's find out if water has shape?

1. Ask the students to pour water into the jars or containers slowly.
2. Observe the way water is slowly filling up the jar/container.
3. Repeat steps 1 and 2 in the other containers.

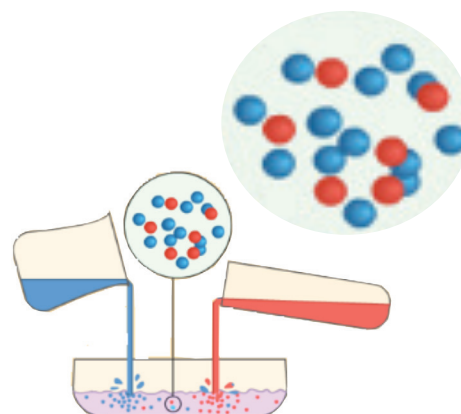

Activity 2: Let's mix two liquids

Summary



- Liquids do not have a shape. They take up the shape of the container.
- Liquids change form when heat is added or removed.

Strand 2 : Physical Science

Unit 3: Matter

Lesson title: Properties of gas



Content standard: 5.2.4 Investigate the relationship between the three states of matter and heat.

Objective: By the end of the lesson students can be able to identify the properties of gases.

Key Concepts

- Gases do not have shape and are colorless.

Materials: variety of plastics that can hold air

Teacher's Notes:

Gases are like liquids, they do not have shape. The biggest difference between a liquid and a gas is that you cannot see most gases. Gases have no shape and most are colorless. Air is one of the most important gases in the world. Air is not a single gas, but a mixture of several gases. All living things need the gas oxygen that is part of air, in order to live. Most gases will change to liquid if they are cooled. This change is called the change of state.

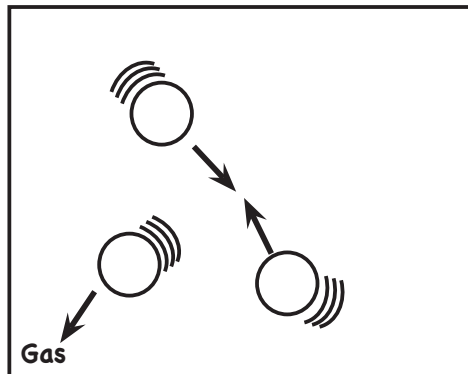

Activity 1: Let's find out if air has shape?

1. Ask the students to blow air into the plastics.
2. Observe the way the air fills the plastics.
3. Repeat steps 1 and 2 in the other plastics.

Discussion Question

1. What is the shape of liquid water?

Summary

- Gas is colourless and takes up the shape of the container.

Strand 2: Physical Science

Unit 3: Matter



Lesson title: Behavior of particles in solid, liquid and gas

Content standard: 5.2.4 Investigate the relationship between the three states of matter and heat

Objective: By the end of the lesson the students can be able to identify the different behaviors of particles in solid, liquid and gas.

Key Concepts:

- Particles in a solid are closely packed.
- Particles in a liquid are close together but not packed as in solids.
- Particles in gases are far apart.

Materials:

Teacher's Notes:

Matter is anything, such as solid, liquid or gas that has weight (mass) and occupies space. For anything to occupy space, it must have volume. Different things of matter behave differently. It is because of their individual properties that they are made up of.

Solids, liquids and gases are all made up of tiny stuff that the naked eye cannot see, called atoms or molecules. The illustration below is an idea of how atoms or molecules in matter look like under a microscope.

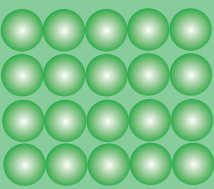
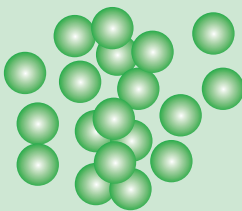
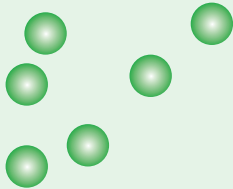
	Solids	Liquids	Gases
Arrangement of molecules	Regular, close to each other	Random or irregular close to each other	Random and wide apart
Movement of molecules	Very little movement in the form of vibration	Molecules can move around each other	Quick movement in random direction
Diagram			
Strength of bond between molecules	Strong bonding	weak bonding	very loose bonding
Examples	a rock	water	water vapour

A : Guided Lessons

Activity

Demonstrate the movement of particles using the children.

Group 1. Particles in Solid. Nicely lined up and close together. (be sensitive to gender)

Group 2. Particles in Liquid. – Stand the children close but not very close like the first group.

Group 3. Particles in Gas. – Stand the children loose. (Emphasize that we cannot see gas because they are far apart.

Summary



- Particles in a solid are closely packed.
- Particles in a liquid are close together but not packed as in solids.
- Particles in gases are far apart.

Strand 2: Physical Science

Unit 3: Matter



Lesson title: Changing states of water

Content standard: 5.2.4 Investigate the relationship between the three states of matter and heat.

Objective: By the end of the lesson students can be able to:

- know that when water is continuously heated, it evaporates and changes to water vapour
- know that when water vapour is cooled, it condenses and forms water.

Key Concepts

- Water can be in a form of solid, liquid or gas

Materials: Bunsen burner, water, flask, bottle of cold water

Teacher's Notes :

Water is found almost everywhere. As a liquid in oceans and rivers, streams, water tanks; as a solid called ice; and as a gas called water vapour or sometimes steam in the air.

If you let a glass of water stand without a cover, the water seems to disappear. In fact it has changed into water vapour and escaped into the air. The particles of which water vapour is made are so small that we cannot see them. When water changes into water vapour, the process is called evaporation. The water vapour moves up into the air. As it moves, the temperature decreases which causes the water vapour to cool down and change into water droplets that form the clouds. The process of water vapour changing into water droplets is called **condensation**. The changes of states from liquid water to gas and back water again can be best explained using the diagram below.

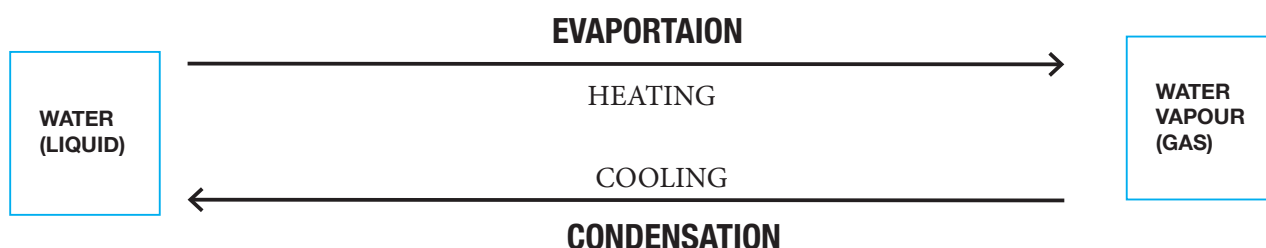

Teaching and learning Activity

1. Ask the students to predict what would happen to the water if it was continuously heated?
2. Allow them to share their opinions with classmates.
3. Set up the bunsen burner and put enough water in the flask (too much water will take long to boil).
4. When the water is boiling, the liquid water changes to steam (water vapour). This process is called **evaporation**.
5. Tell the children to place the bottle of cold water in the steam for few minutes then remove it.
6. Ask the students to see what is outside of the bottle.
7. Tell the children that when steam which is a gas is cooled down, it changes into water which is a liquid. This change is called **condensation**.

Strand 1 : Life

Unit 1: Plant



Lesson title: Conditions for plant growth

Content standard: 5.1.1 Investigate and understand the conditions required for seed germination and plant growth.

Objective: By the end of the lesson the students can be able to identify and explain the conditions for plant growth.

Knowledge, skills, attitudes and values:

Knowledge	Skills	Attitudes
<ul style="list-style-type: none"> Plants need better conditions for growth. Plants need nutrients, air, water and sunlight in order to grow. 	<ul style="list-style-type: none"> Identify suitable conditions for plant growth. Identify needs for plants in order to grow. 	Respect opinions of others.

Materials:

Teacher's Notes :

Once a seed has used up all the stored food, it must start making its own food in order to survive. The green pigment in the leaves called **chlorophyll** helps the plant make food. Chlorophyll absorbs light energy, and light energy combines with water and carbon dioxide from the air to make food. This process is called **photosynthesis** which means “putting together with light”. During photosynthesis, the plants give off oxygen. Green plants are very important to people because people get food and oxygen from them.

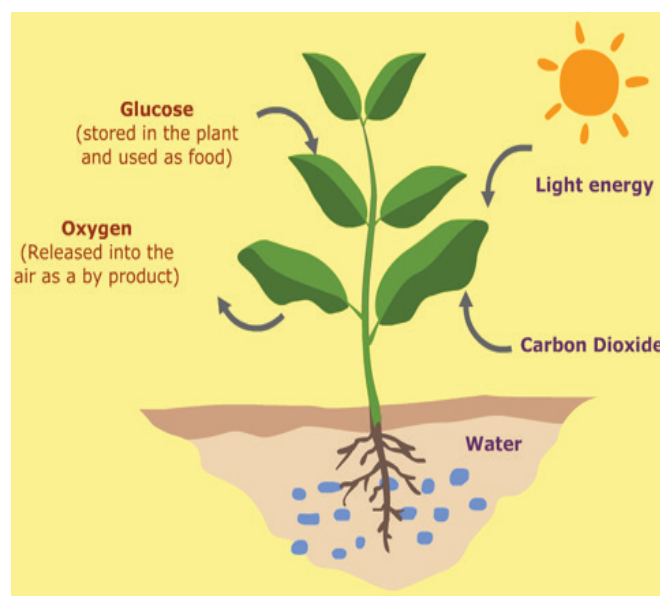

Summary

Plants need nutrients, air, water and sunlight in order to grow. If they don't get enough of this things, they will die.

Strand 1: Life

Unit 2 : Animals



Lesson title: Reproduction process in human beings

Content standard: 5.1.2 Understand that living things reproduce to ensure continuity of their kind.

Objective: By the end of the lesson students can be able to explain the reproductive process of Human beings.

Key Concepts

- Fertilization of humans occur internally.
- Human beings produce babies.

Knowledge, skills, attitudes and values:

Knowledge	Skills	Attitudes
<ul style="list-style-type: none"> • Reproduction in humans involves internal fertilization. • Males produce sperm while females produce eggs. 	Label the reproductive system correctly for both male and female.	Respect each other's opinion.

Materials: Reproduction process in human beings chart.

Teacher's Notes:

This lesson is very sensitive in nature and must be delivered in a way that is acceptable to both the students and the teachers. You are advised to be selective in the words you use in imparting the content.

The human reproductive system usually involves internal fertilization by sexual intercourse. During this process, the male inserts his erect penis into the female's vagina and ejaculates semen which contains sperm. A small portion if the sperm passes through the cervix into the uterus and then into the fallopian tubes for fertilization of the ovum. Only one sperm is required to fertilize the ovum. Upon successful fertilization, the fertilized ovum, or zygote travels out of the fallopian tubes and into the uterus, where it implants in the uterine wall. This is the beginning of pregnancy which continues for nine months as the fetus develops. When the fetus has developed to a certain point, the baby is delivered. Human infants are nearly helpless and require high levels of parental care. Infants depend really on their caregivers for comfort, cleanliness and food. Food may be provide by breastfeeding or formula feeding.

Strand 1: Life

Unit 2: Animals



Lesson title: Reproduction process of dogs

Content standard: 5.1.2 Understand that living things reproduce to ensure continuity of their kind.

Objective: By the end of the lesson the students can be able to:

- know how dogs reproduce
- know that fertilization takes place inside the body of the female dog.

Key Concepts:

- Reproduction in dogs occur internally.
- Dogs produce puppies.

Knowledge, Skills, attitudes and values:

Knowledge	Skills	Attitudes
<ul style="list-style-type: none"> • Dogs generally reach sexual maturity at about six months of age. • Reproduction in dogs occurs internally. 	<ul style="list-style-type: none"> • Define the terms of the dog's reproductive system. • the parts of the dog's reproductive system. 	<ul style="list-style-type: none"> • Appreciate dogs as humans best friend.

Materials: Chart, A4 papers, pencils, glue, sticky tape.

Teacher's Notes :

1. Production of Sex cells.

- Male sex cells (sperm) are made in the testes of adult males.
- Female sex cells (egg cells) are made in the ovaries of adult females. Only a few egg cells are produced as most will be fertilized.

2. Mating

- The male dog mates with the female dog and deposits sperm inside her body.

3. Fertilization

- This takes place inside the body of the female. The sperm swim towards the eggs and fertilization occurs when a sperm cell joins with an egg cell.

4. Development

- This also takes place inside the body of the female in a special part called the uterus (womb). The embryos (usually about 3 to 6) develop inside the uterus for about 4 months receiving food from the mother. After this time the puppies are born almost fully formed, and then fed on milk from their mother's mammary glands (susu). For this reason, newborn puppies tend to stay close to their mother or cuddle together for warmth. Mothers clean, nurse, and defend their puppies until they can live on their own, but fathers do not involve themselves in the care of the young.

Summary



- The male sex cells are made in the testes and the female sex cells are made in the ovaries of the adult dog.
- Fertilization in dogs takes place inside of the female dog.
- The development takes place inside the body. They are cared for and protected by their parents until they become independent.

A : Guided Lessons

Lesson No.28

Strand 1 : Life

Unit 2: Animals



Lesson title: Reproduction process of birds - Chicken

Content standard: 5.1.2 Understand that living things reproduce to ensure continuity of their kind.

Objective: By the end of the lesson students can be able to:

- know how chickens reproduce
- know that fertilization takes place inside the body of the female chicken.

Key Concepts

- Young chicken grows inside the egg shell using the food stored there.
- Most chicks survive to become adult chickens because the hen looks after them.

Knowledge, skills, attitudes and values:

Knowledge	Skills	Attitudes
<ul style="list-style-type: none">• In order to reproduce, the hen must find a rooster to mate.• The eggs are in the hen's body without shells	<ul style="list-style-type: none">• Understand the reproduction process of chickens	<ul style="list-style-type: none">• Appreciate the existence of the chicken

Materials: Reproduction of Chicken Chart, A4 papers,

Teacher's Notes:

1. Production of Sex cells.

- Male sex cells (sperm) are made in the testes of adult males (roosters or cocks)
- Female sex cells (egg cells) are made in the ovaries of adult females(hens). Only a few egg cells are produced as most will be fertilized.

2. Mating

- The male chicken mates with the female chicken and deposits sperm inside her body.

3. Fertilization

- This takes place inside the body of the female. The sperm swim towards the eggs and fertilization occurs when a sperm cell joins with an egg cell.

4. Development

- This commences inside the body of the female but mostly occurs outside her body. After fertilization has occurred the zygote is surrounded by food (the white and the yolk) of the egg, and is coated with a protective shell. After about 1 day the egg is laid through the same opening the sperm entered during mating.

Development of zygote into embryo and then into a young chicken continues inside the egg for about 21 days using the stored food in the egg.

The hen sits on the eggs to keep them warm while the chicks are developing inside them. After they hatch out the mother continues to look after them for about 6 weeks therefore making sure that most will survive to become adult chickens.

A : Guided Lessons

Activity

Write down True or False next to each of these sentences.

1. The sperm fertilizes the eggs while they are still inside the female chicken's body. _____
2. The hen looks after her chicks when they are small. _____
3. Female chickens lay a large number of eggs at one time. _____
4. A hen's egg is a big because it contains food for the growing chick. _____
5. When a male and female chicken mate not many of the eggs will be fertilized. _____

Summary



- The male sex cells are made in the testes of the rooster and the female sex cells are made in the ovaries of the hen.
- Only few eggs are produced as most will be fertilized.
- Fertilization in chickens takes place inside of the hen.
- The development takes place inside the body but mostly occurs outside of the body. They are cared for and protected by their parents until they become independent.

Strand 1 : Life

Unit 2: Animals



Lesson title: Reproduction process of a fish

Content standard: 5.1.2 Understand that living things reproduce to ensure continuity of their kind.

Objective: By the end of the lesson students can be able to:

- know how fish reproduce
- know that a very large number of eggs are made, but few are fertilized and grow into adult fish
- know that fertilization takes place outside the body of the female fish.

Key Concepts

- The fertilization and development of fish takes place outside the body of the female body.

Materials: Flash cards

Teacher's Notes:

1. Production of Sex cells.

- Male sex cells (sperm) are made in the testes of adult males.
- Female sex cells (egg cells) are made in the ovaries of adult females. Thousands of egg cells are produced as many will not be fertilized and many will be eaten by other fish and not survive.

2. Mating

- Most fish do not actually mate but they behave in a way which brings males and females close together (see diagram).

3. Fertilization

- This takes place outside the body of the female. The female lays her egg cells in the water and the male then deposits his sperm on or near them. The sperm swim to the egg cells and fertilise them- one sperm joining with one egg.

4. Development

- The development of the zygote takes place outside the body of the female. Little or no care is given by the parents so that many zygotes and young fish do not survive to become adults.

Teaching and learning:

Activity 1: True or False

Write down True or False next to each of these sentences.

1. The fertilized eggs grow into baby fish. _____(True)
2. The eggs are fertilized inside the body of the female fish. ____ (False)
3. All baby fish grow into adult fish. _____(False)
4. A female fish lays thousands of eggs. _____(True)
5. A male fish makes sperm. _____ (True)

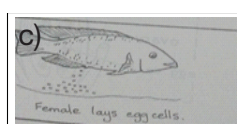
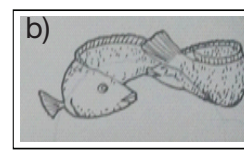
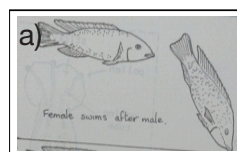

Activity 2:

1. From the pictures above jumble the diagram (use the letters A-D).
2. Tell the students to write them in the correct order.

A : Guided Lessons

Lesson No.31

Strand 1: Life

Unit 2: Animals



Lesson title : Compare the reproductive process of humans and birds

Content standard: 5.1.2 Understand that living things reproduce to ensure continuity of their kind.

Objective: By the end of the lesson the students can be able to:

- compare the reproduction process of humans and birds
- identify the similarities and differences of humans and bird reproduction process.

Key Concepts:

- The male sex cells (or sperm) are made in the testes of adult male and the female sex cells (eggs) are made in the ovaries of the adult female of both birds and humans.
- Fertilisation in humans and birds takes place inside the body.

Knowledge, skills, attitudes and values:

Knowledge	Skills	Attitudes
<ul style="list-style-type: none">• The development of humans takes up to 9 months inside the body.• The development of birds takes up to about a month depending on the type of bird.	<ul style="list-style-type: none">• Compare the reproduction process of both human and birds.• List the similarities and differences of the reproduction process of humans and birds.	<ul style="list-style-type: none">• Appreciate the results after comparing both reproduction process.• Respect their classmates opinions.

Materials: Reproduction chart of humans and birds.

Teacher's Notes :

From the previous lessons, the topics have been covered on the reproductive system of a bird (Note that the word bird can also refer to chickens) and reproductive system of human.

Make a comparison of the similarities and differences of the Human and Chicken Reproduction process.

Teaching and learning:

Activity:

Complete the table by listing all similarities and differences of the human reproductive system and chicken reproductive system.

	Production of sex cells	Mating	Fertilization	Development
Humans				
Birds				

A : Guided Lessons

Lesson No.32

Strand 1 : Life

Unit 2: Animals



Lesson Title: Heredity characteristics of animals

Content standard: 5.1.2 Understand that living things reproduce to ensure continuity of their kind.

Objective: By the end of the lesson students can be able to explain the offspring look like their parents.

Key Concepts

- An offspring cell or organism acquires the characteristics of its parent cell or organism.
- List certain characteristics that off springs inherit from their parents.

Materials: Picture of a parent and an offspring

Teacher's Notes :

Heredity is the transfer of qualities from parents or ancestors to their offspring. This is the process by which an offspring cell or organism acquires the characteristics of its parent cell or organism. Heredity is the passing on of characteristics from one generation to the next. It is the reason why offspring look like their parents. It also makes clear why cats for example always give birth to cats.

Teaching and learning:

Activity A:

Complete the table by writing the correct parent and its offspring under each column.

Parents (Animal)	Offspring (Animal)
<i>Eg.</i> Human	Babies
Cow	
	Kitten
Pig	
	Puppy

Strand 3: Earth and Space

Unit 2 : Wheather and Climate

Lesson title : Types of clouds



Content standard: 5.3.2 Investigate weather and seasons and the effects they have on living things and the environment.

Objective: By the end of the lesson the students can be able to name the different types of cloud.

Key Concepts:

- There are four primary clouds which have specific features of their own.

Materials: Beaker, Ice, Match sticks (smoke), water (hot and cold)



- Be careful when handling glass beakers.
- Take extra care when using matchsticks and hot water.

Teacher's Notes :

All clouds are found in the troposphere, which is the lowest layer of the atmosphere. Clouds are named according to their height, shape and what they contain.

Names have been given to the different types of clouds. These names come from Latin and they describe five main types of cloud.

Word or part of word	Word or part of word
Cirrus (cirro)	Are made of ice crystals (curl of hair, high)
Cumulus (cumulo)	Are heaped (piled or heaped)
Nimbus (nimbo)	Bring rain (water or rain bearing)
Stratus (strato)	Make layers (spread over)
Alto	Are higher up

Other cloud types can be described by joining these words in different combinations. For example, cumulonimbus is a type of rain cloud that is heaped and brings rain.

Cumulus Clouds

On a warm sunny day we often see clouds that look like cotton balls. They are flat across the bottom. These are called “cumulus clouds. They form warm air bubbles upwards and reaches cold air higher in the atmosphere, and water vapour in the air condenses.

Cumulonimbus

Cumulonimbus clouds, or thunderclouds, are very tall cumulus clouds. The bottom is low, and they can reach 15 kilometers in height. They form when cumulus clouds pile up and up, as more moist air rises. They become full of water drops low down. They usually bring rain and can also bring thunderstorms, lightning and even tornadoes.

A : Guided Lessons

Nimbostratus clouds

Nimbostratus clouds, or rain clouds, form a dull grey blanket of cloud in the sky. They are found at a fairly low level, and bring damp or wet weather. They are grey because the raindrops in them block the sunlight.

Cirrus Clouds

Cirrus clouds, or ice clouds are very high and are made of ice crystals. They make wispy feathery patterns, which are created by winds blowing high in the atmosphere. Cirrus clouds do not bring rain. Cirrostratus clouds form flat ice veils across the sky.

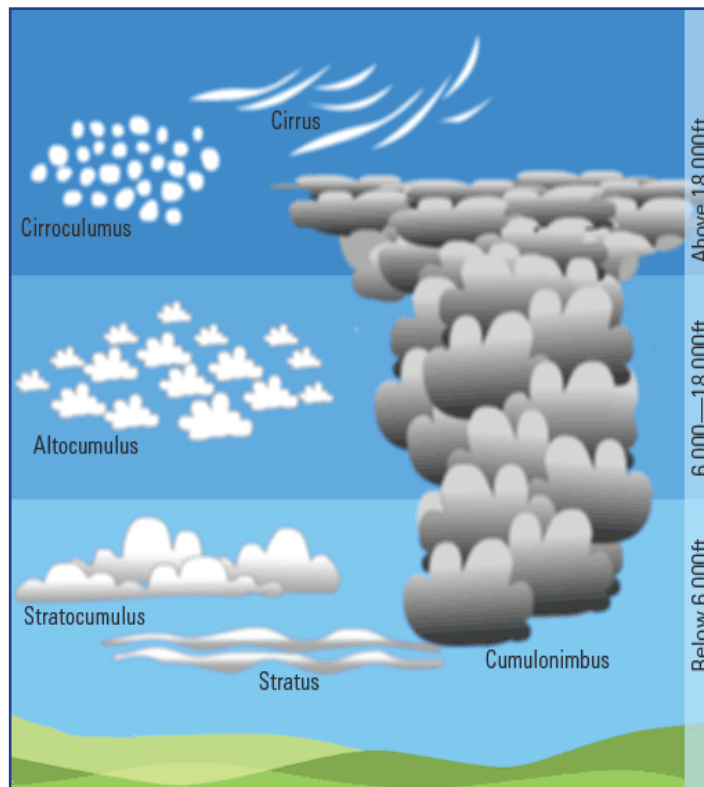

Teaching and learning

Activities

Let's make Clouds

1. In groups discuss the question "How are Clouds formed?"
2. Share opinions and reasons to the class.
3. Prepare a beaker with warm water and ice cold water.
4. Light the match stick and blow it out above the warm water beaker (make sure some smoke goes into the beaker).
5. Put the beaker with ice water (cold water) above the other beaker.
6. Observe and describe the results based on the experiment.

Discussion

Why are some clouds dark and others white?

Strand 3: Earth and Space

Unit 2: Weather and Climate

Lesson title : Seasons of the world



Content standard: 5.3.2 Investigate weather and seasons and the effects they have on living things and the environment.

Objective: By the end of the lesson the students can be able to identify the four seasons of the world.

Key Concepts:

- The tilt of the earth causes the seasons.
- The four seasons of the world are **winter, spring, summer and autumn.**

Materials: World Globe, Torch, paper plate, marker, scissors, ruler, protractor (or a circular base to draw the circle)

Teacher's Notes :

Earth season is about three months long and is characterized by weather, temperature and length of day. The seasons change because the tilt of the earth's axis stays the same as the earth orbits the sun. Because the earth's axis is tilted half of the earth is tipped either toward or away from the sun. The Northern hemisphere receives the most direct sunlight during June when it is tilted toward the sun. Because the Southern Hemisphere is tilted away from the sun in June, it receives less direct sunlight. During this time, it is winter in the Southern Hemisphere. The opposite occurs in December; it is winter in the Northern Hemisphere and summer in the Southern Hemisphere

The four seasons of the world are **winter, spring, summer and autumn.**

The teacher can use a world globe and a torch to represent the sun. Use a country that is further away from the equator as an example and show how the Earth's tilt, rotation and revolving affects the proximity to the sun, therefore affecting climate and producing seasonal variations.

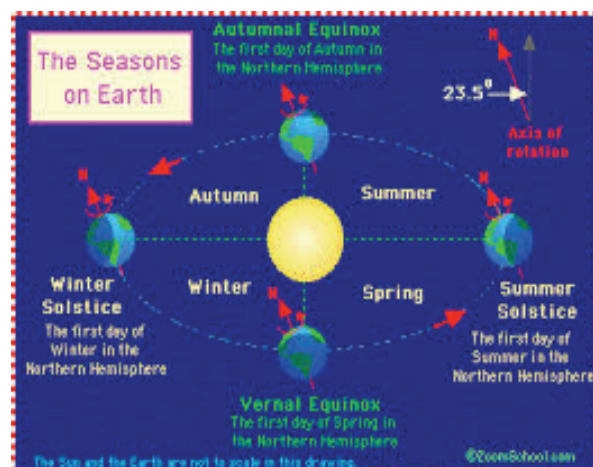
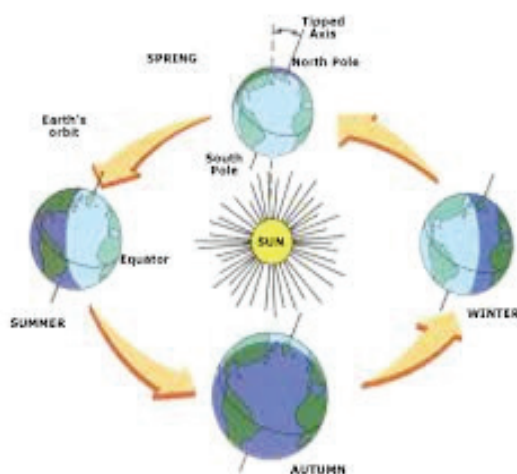

Teaching and learning

Activity 1: Season Clock

1. On paper plates create a four season clock.
2. Paste pictures cut from all magazines into the appropriate section,

Strand 1: Life

Unit 4: Interaction and Relationship in the Environment



Lesson title: Living things need food

Content standard: 5.1.5 Investigate and explain the energy pathway from the Sun through to the living things.

Objective: By the end of the lesson students can be able to explain that living things need food to survive in different habitats.

Key Concepts

Knowledge	Skills	Attitudes
<ul style="list-style-type: none"> Living things need food to survive. All living things depend on each other for food. 	<ul style="list-style-type: none"> Identify the different food source found in the habitat. Observe how living things feed on its food source. 	<ul style="list-style-type: none"> Taking care of the food source in an habitat.

Materials: Chart of Rainforest, ocean, grassland, wetland, mountain



- Be careful when handling glass beakers.
- Take extra care when using matchsticks and hot water.

Teacher's Notes :

Habitat is the environment in which certain plants and animals depend on each other for survival. The same habitat does not provide food for all living things. When a habitat is destroyed, only the living things that depend on the particular habitat will be affected, for example the mangrove. When affected living things depart, other living things that depend on them will then also be affected.

Teaching and learning:

Key Question:

Activity 1: Make a list of the living things that survive or depend on it for food.

Activity 2: When a habitat is destroyed,

- What will happened to the living things that survive on it for food?
- How will it affect other living things?

Activity 3: Pay a visit to a certain habitat within the school area.

Summary



- Living things need energy in order to stay alive.
- Plants provide energy for all living things.

Strand 1: Life

Unit 4: Interaction and Relationship in the Environment



Lesson title: Animals get energy from plants

Content standard: 5.1.5 Investigate and explain the energy pathway from the Sun through to the living things.

Objective: By the end of the lesson students can be able to identify and explain the process involve in the transfer of energy from plants to animals.

Key Concepts

- Animals need energy to live.

Knowledge	Skills	Attitudes
<ul style="list-style-type: none"> Plants make their own food through the process called <i>photosynthesis</i>. Animals do not make food. 	<ul style="list-style-type: none"> Differentiate between producers and consumers. Draw a simple food chain. The flow of energy is represented by an arrow. 	<ul style="list-style-type: none"> Appreciate that the environment provides food for all living things.

Materials: Photos of grassland and grass eating animals.

Teacher's Notes:

Plants make their food using the light from the sun through the process of photosynthesis. They store up energy gained from then sun. The plants are called **producers** because they are the basic source of energy for living things. Animals are called **consumers**. They only eat and cannot make their own food. The animals that eat plants for food are called **herbivores**. Cow, grasshopper and rat are examples of herbivores.

Teaching and learning:

Key Question: where is the energy coming from?

Activities

1. Circle the correct answer. Which of the following listed are producers?

Group 1	Group 2	Group 3
flowers dugong corn bird grasshopper	frog seaweed bird caterpillar taro	butterfly human green weed grass bird

2. Draw pictures of this food chain



Summary



- Animals depend on plants for food.
- Animals that get energy from the plants are called herbivores

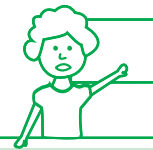

Strand 1: Life

Unit 4: Interaction and Relationship in the Environment

Lesson title: Animals get energy from other animals

Content standard: 5.1.5 Investigate and explain the energy pathway from the Sun through to the living things.

Objective: By the end of the lesson students can be able to explain the reason why animals eat other animals.

Key Concepts

- Animals cannot make their own food.
- Animals depend on other livings for food.

Knowledge	Skills	Attitudes
<ul style="list-style-type: none"> • Animals cannot make their own food. • Animals eat other animals to get energy. 	<ul style="list-style-type: none"> • Draw a simple food chain. • Explain the transfer of energy from an animal to another. 	<ul style="list-style-type: none"> • Respect views of their friends.

Materials: Photos of animals, carnivores, omnivores

Teacher's Notes:

Plants are called producers. They produce food for other living things. Animals are called **consumers**. The animals that feed directly on plants are called **herbivores**. These animals are then eaten by other animals called **carnivores**. This can be shown in a **food chain**. A food chain is the flow of energy from the producer to the consumer.

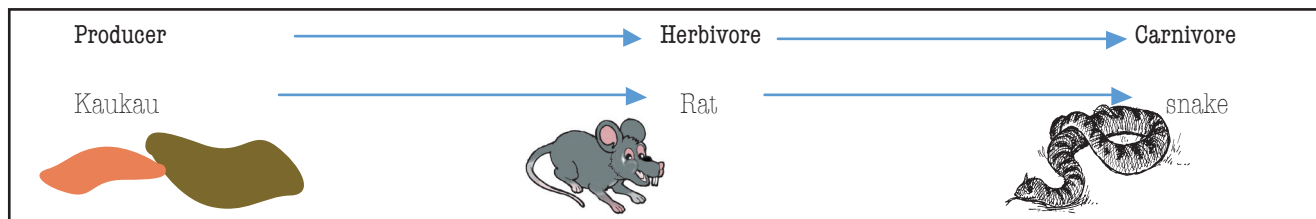

Teaching and learning:

Activity 1: Fill in the blanks with the following words.
(herbivore, producer, carnivore)

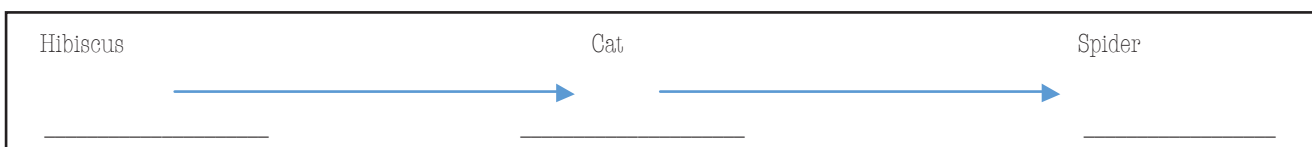

Summary

- Some animals depend on other animals for food.
- Animals that eat animals for food are called carnivores.

Strand 2: Physical Science

Unit 2: Force and Motion

Lesson Title : Types of levers



Content standard: 5.2.3 Investigate and explain changes in motion of objects and the regularity of levers.

Objective: By the end of the lesson the students can be able to identify and classify leavers according.

Key Concepts:

- Leavers are used to move heavy loads with less force.

Materials: plank, load, brick or stone (fulcrum)

Teacher's Notes :

Levers have very important parts- the bar or beam, the fulcrum (the pivot or turning point), effort (or force) and the load.

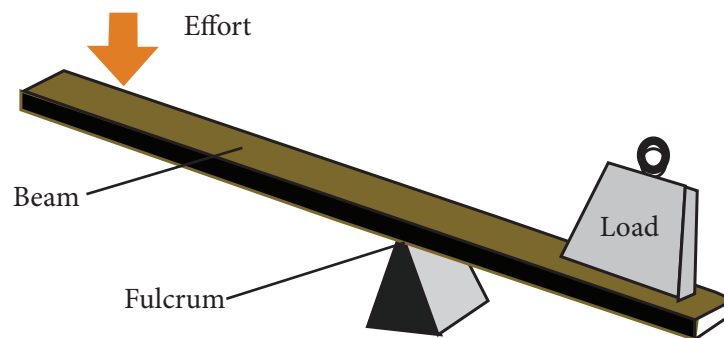

The beam is simply a long plank. It may be wood, metal or any durable material. The beam rests on a fulcrum (a point on the bar creating a pivot.)

When you push down one end of a lever, you apply a force (input) to it. The lever pivots on fulcrum, and produces an output force on the load. A lever makes work easier by both increasing your input force and changing the direction of your input force.

The parts of the lever are not always the same arrangement. The load, fulcrum and may be at different places on the plank.

Three Classes of Levers

Class One Lever - In this class, the Fulcrum is between the Effort and the Load. The mechanical advantage is more if the Load is closer to the fulcrum. Examples of Class One Levers include seesaws, boat oars and crowbar.

Class Two Lever - In this class, the Load is between the Effort and the Fulcrum. The mechanical advantage is more if the load is closer to the fulcrum. Examples of Class Two Levers include wheelbarrows.

Class Three Lever - In this class, the Effort is between the Load and the Fulcrum. The mechanical advantage is more if the effort is closer to the load. An example of Class Three Lever is a garden shovel.

A : Guided Lessons

Lesson No.57

Strand 3: Earth and Space

Unit 1 : Our Earth

Lesson title: What is a rock?



Content standard: 5.3.1 Investigate the characteristics and properties of rocks and minerals.

Objective: By the end of the lesson students can be able to explain what a rock is.

Key Concepts

Rocks are made of two or more minerals

Materials:

Teacher's Notes :

Rocks are very tiny grains of very different minerals, compressed together in chemical reaction to form a bigger mass. They are made of two or more different minerals. They may also contain organic compounds. Rocks make up no-water part of the earth's crust.

Rocks may be hard or soft. It depends on the way the tiny grains interlock with each other. Rocks with rough grains fitting perfectly into each other tend to leave no room for moisture. As a result, they are harder and **non-porous** in nature. Granite is a great example.

Rocks with rounded or fine grain often have spaces that hold moisture and tend to be softer. They crumble quicker than hard rocks. Rocks that have lots of spaces holding water, or through which water can pass are called **porous rocks**. Sandstone is an example of porous rocks.

Interlocking grains with no water or air spaces

Non-porous rock



Rounded grains with more air and water spaces

Porous rock

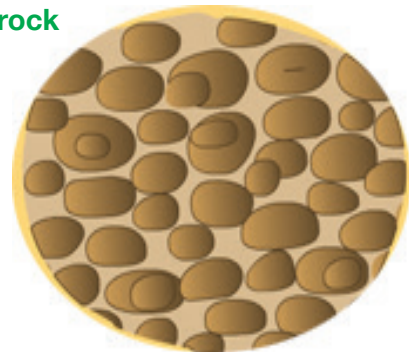

Summary

- Rocks are made of two or more minerals.

Strand 2 : Physical Science

Unit 1: Energy



Lesson title: What is heat?

Content standard: 5.2.1 Investigate and explain the properties of heat energy.

Objective: By the end of the lesson students can be able to understand heat as a form of energy.

Key Concepts

- Heat is a form of energy

Teacher's Notes:

Heat is a form of energy that can make things hot. Heat is not a material object like a solid, liquid or gas. It doesn't have shape or size. You cannot see heat but you can feel it and see what it does. Heat comes from different places. It comes from the sun, a fire a burning candle, electricity, rubbing things together, our bodies etc. We can see heat in action when water is boiled, food is cooked, ice melting, sun dries wet clothes or warms our bodies

We can tell how hot something is by touching it. Sometimes this is very dangerous because the object touched may be too hot and might burn the skin

Teaching and learning

Key Question: What happened to the towel?

Activity:

Have small groups wet two paper or cloth towels. Then have them put one towel in a sunny spot outside or inside and another in a cool, dark place. Ask the students to predict how they think sunshine or lack of sunshine will affect the damp towels. Later have the students observe which towel is dryer. How did the heat affect the way the towel dried? Where did the water in the towel go? Remind the students that heat can cause matter to change states.

Strand 2: Physical Science

Unit 1: Energy

Lesson title : Heat transfer - Conduction



Content standard: 5.2.1 Investigate and explain the properties of heat energy.

Objective: By the end of the lesson the students can be able to understand conduction of heat in material.

Key Concepts:

- Heat can move by conduction.

Materials: Metal/Iron rod (1metre), Box (shelter)

Teacher's Notes :

Heat moves from places where the temperature is higher to places where the temperature is lower. The way in which heat moves depends on whether the material is solid, liquid or gas.

Teacher's Activity

Prior to the lesson place the rod in the sun for 2-4 hours in an open space. Other half of the rod to be expose to the sun's direct heat while the other half of it is shelter from the sun using the box. Mark the center of the rod with a marker.

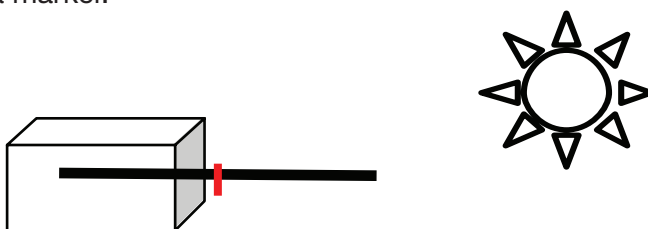

The lesson will be effect if the Sun's ray is at its most heat.

Teaching and Learning Activities

Feel the rod and note their findings.

1. Feel the temperature of rod from the two different ends.
2. Complete the table below.

Rod	Temperature(tick the answer to your findings)
1. Exposed part of rod to the sun	hot <input type="checkbox"/> warm <input type="checkbox"/> cold <input type="checkbox"/>
2. Shelter part of the rod from the sun	hot <input type="checkbox"/> warm <input type="checkbox"/> cold <input type="checkbox"/>

1. What caused the rod to be hot? (sun's heat)
2. Why is the rod hot/warm even it was sheltered from the sun? (heat move through the rod)

Summary

- Heat moves from places where the temperature is higher to places where the temperature is lower.
- Conduction occurs when two objects of different temperature are placed in direct contact with each other.

Strand 2: Physical Science

Unit 1: Energy



Lesson title: Measuring and reading temperature

Content standard: 5.2.1 Investigate and explain the properties of heat energy.

Objective: By the end of the lesson students can be able to:

- perform and experiment to measure temperatures of hot water
- confidently read temperature readings on a thermometer.

Key Concepts

- A Thermometer is an instrument used to measure temperature.
- Temperature is how hot or cold something is.

Materials: Flat bottom flask, boiling stones, thermometer, match, water, ice

Teacher's Notes :

All materials or objects solids, liquids and gases change when they are heated or cooled. The amount of change depends on the amount of heating and cooling. When you heat solids, liquids and gases, they get a lot of energy, therefore getting bigger and taking up more space. The find out the temperature of the object, we use a thermometer. A thermometer is an instrument that is used to find how hot or how cold something is.

If you place a thermometer into hot water, the liquid inside the thermometer rises up in the tube of the thermometer.

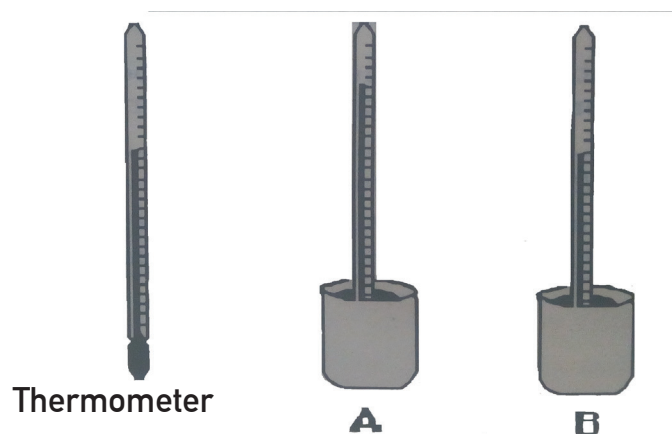

The thermometer in container **A** has been placed in hot water. The liquid inside the thermometer has been heated and gotten bigger. This has caused the liquid to go higher in the tube. The thermometer in container **B** has been placed in cold water. The liquid in the tube of the thermometer has gotten smaller and gone down the tube.

Teaching and learning

Key Question: What happens to the temperature if water is continuously heated?

A : Guided Lessons

Activity:

Predictions: The temperature reading will be close to 100 degrees

1. Predict how the temperature of water changes when it is continuously heated and share your idea with your classmates.
2. Set up the experiment as shown.
3. Fill the flat bottom flask with 100mL water and mark the level. Remember to put in boiling stones.
4. Start heating the water and measure temperature every 2 minutes, observe what is happening and record in a table like the one below.
5. After a while turn off the flame, observe what will happen and check the water level.

Time	Temperature	Describe the condition of water
00 mins		
02 mins		
04 mins		
06 mins		
08 mins		
10 mins		
12 mins		
14 mins		
16 mins		
18 mins		
20 mins		
22 mins		
24 mins		
26 mins		
28 mins		
30 mins		

Note: Record the initial temperature of water before heating the beaker.

Strand 2 : Physical Science

Unit 1: Energy



Lesson title : Connecting in series circuit

Content standard: 5.2.2 Investigate and identify the properties of electric circuits.

Objective: By the end of the lesson the students can be able to identify and explain the connection pattern of a series circuit.

Key concepts:

Knowledge	Skills	Attitudes
<ul style="list-style-type: none"> Understand the connection in a series circuit. The components are connected in a single loop. 	<ul style="list-style-type: none"> Demonstrate how to connect bulbs in series. Identify devices where series circuit is used. 	<p>Appreciate series circuit and its connection.</p>

Materials: Wire, switch, battery and lamp



- Be careful when handling lamps. It can break easily.

Teacher's Notes:

These lesson will require the teacher to prepare enough bulbs and batteries for all students. In the case where there is no bulb socket, use wires. Ensure that the wire are long enough.

In a series circuit, electric current flows in a single path. The wire links all the components together in a single path. The wire must be in contact with each component in order for the current to flow. Advise the students to take note of the brightness of the bulbs as more bulbs are added.

Insert diagram of series circuit (without symbol)



A : Guided Lessons

Teaching and learning

Key Question: How does a series circuit look like?

Predictions

The bulbs will have the same brightness.

Activity: 1 connecting in a series circuit.

1. Using the materials provided, make a series circuit.

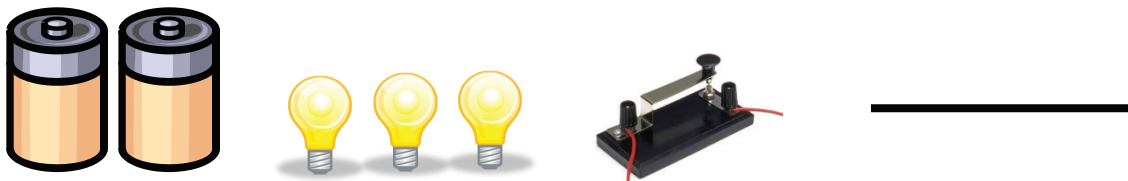

Close the switch to complete the connecting of the circuit.

Predictions

- The lamp(s) glow(s) will have different brightness.

Discussion

After connecting the components in a series circuit

1. What happens to the lamp if the switch is closed?
2. What happens to the lamp if the switch is open?
3. How many set of wires between the battery, switch and the lamp?

Summary



- Current flow in a different paths.

Strand 2: Physical Science

Unit 1: Energy

Lesson title : Making a bulb brighter



Content standard: 5.2.2 Investigate and identify the properties of electric circuits.

Objective: By the end of the lesson the students can be able to explain the process involved in making a bulb brighter.

Key Concepts:

- To make the bulb brighter, add more energy.

Knowledge	Skills	Attitudes
<ul style="list-style-type: none"> • The brightness of the bulb increases when more electric energy is added 	Observe the difference in the brightness of the bulb	Appreciate brightness of the bulb

Materials: Wires, switch, battery and lamps.



- Be careful when handling lamps. It can break easily

Teacher's Notes :

The brightness of the bulb depends on the various component connected in the two (parallel/series) circuits. Less source of electric energy (batteries) and more bulbs can influence the brightness in each bulb. Adding more batteries to a single bulb can cause the bulb to burn out.

Teaching and Learning

Key Question: "How can we increase the brightness in a bulb? "

Activity: Explain the process of the increasing the brightness of the bulb.

What to do:

Answer the following by explaining;

1. What happens to the brightness of the bulb?
2. Close the switch to complete the connecting of the circuit.

Predictions

- The lamp glows when the connection is complete

Discussion

After connecting the components in a series circuit

What happens to the lamp if the switch is closed?

What happens to the lamp if the switch is open?

How many set of wires between the battery, switch and the lamp?

A : Guided Lessons

Lesson No.81

Strand 2: Physical Science

Unit 1: Energy

Lesson title : Using symbols to draw circuits



Content standard: 5.2.2 Investigate and identify the properties of electric circuits.

Objective: By the end of the lesson the students will be able to use symbols to draw circuit diagrams.

Key Concepts:



- Symbols are used to represent components of a circuit.

Knowledge	Skills	Attitudes
<ul style="list-style-type: none"> • Symbols represent certain components of a circuit. 	<ul style="list-style-type: none"> • Draw the symbols to represent the different components of the circuit. 	<ul style="list-style-type: none"> • Appreciate the use of symbols in circuits.

Materials: Wire, switch, batteries and bulb

Teacher's Notes :

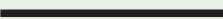
Electricity flows from a source like a battery along wires to a place where it is used, such as bulb, then back to the battery. When this happens, it is a complete or closed circuit. Electricians use special symbols to draw circuits. They are the special language of electricity.

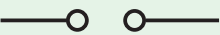
	Bulb
	Wire
	Open switch
	Closed Switch

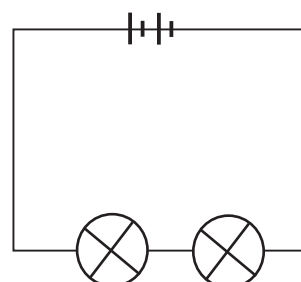
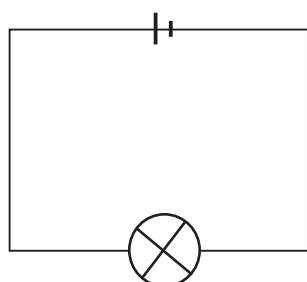

A : Guided Lessons

Teaching and learning

ACTIVITY:

Let's draw a circuit using symbols.

Activity 1

Draw a circuit diagram using symbols which have the following

a) Two batteries, two bulbs with an open switch



b) Two batteries, three bulbs with a closed switch

Activity 2



B. Knowledge Skills Attitudes and Values

Strand	Content Standard	Performance Standard	Lesson Title/ Lesson No:	Knowledge	Skills And Processes	Values And Attitudes
Life	5.1.4	a) Identify the different types of adaptation.	Different types of habitat- Wetlands Lesson No: 5	<ul style="list-style-type: none"> Animals live in varied habitats on land and in water 	Describe the different kinds of animals that live in water	Care for the living things that are found in wetland areas
Life	5.1.4	d) Identify and explain the different types of adaptation.	Adaptation – Feeding Lesson No: 9	<ul style="list-style-type: none"> Each animal has its own way of getting, chewing and digesting food 	Identify the different ways animal feed- types of beak, type of teeth Classify animals according to how they eat	Develop caring attitudes towards animals.
Life	5.1.4	d) Identify and explain the different types of adaptation.	Adaptation- movement Lesson No: 10	<ul style="list-style-type: none"> Animals move in different ways depending on body structure Water animals move differently from land animals 	Identify the different ways animal move - swim, fly, walk Classify animals according to how they move	Develop caring attitudes towards animals.
Life	5.1.4	d) Identify and explain the different types of adaptation.	Adaptation – Protection Lesson No: 11	<ul style="list-style-type: none"> Camouflage is the most common protective coloration Mimicry is means of protection in which one animal resembles another animal that is dangerous 	Identify animals which camouflage with the environment Imitate sounds of various animals	Show curiosity to learn about animals
Physical Science	5.2.4	a) Explain the physical properties of solid, liquid and gas in terms of shape.	Similarities and differences between solids, liquids and gases Lesson No: 17	<ul style="list-style-type: none"> Solids, liquids and gases occupy space Solids have shapes of their own Liquids do not have shape of their own. They take the shape of the container Gases have no definite shape 	Demonstrate that solids, liquids and gases occupy space Investigate the different shapes of solids, liquids and gases	
Physical Science	5.2.4	c) Describe the relationship between change in temperature and change in states of matter	Changes of states and temperature Lesson No: 19	<ul style="list-style-type: none"> A substance changes its state when it gains heat or loses heat 	Investigate the effect of heat on water Measure the temperature of each change of state	

B. Knowledge Skills Attitudes and Values

Life	5.1.1	c) Compare the conditions necessary for seed germination and plant growth.	Compare between conditions of seed germination and plant growth Lesson No: 23	<ul style="list-style-type: none"> Seeds need water, air and the right temperature to germinate Plants need soil, water, sunlight and air to grow. 	Construct experiments which test the basic factors needed for seed germination and plant growth	Give explanations based on observation
Life	5.1.1	e) Explain how plants make food through the process of photosynthesis.	How plants make their own food Lesson No: 24	<ul style="list-style-type: none"> Plants make food using energy from the sun, carbon dioxide from air and water absorbed through the roots 	Predict what would happen if there was no sunlight	Respect their classmates opinions
Life	5.1.2	a) identify and explain the reproduction process of different animals.	Reproduction process in dogs Lesson No.29	<ul style="list-style-type: none"> Reproduction in dogs occur internally. Male dog produces sperm while female dog produce egg cell 	Explain the reproduction cycle of dogs	
Earth and Space	5.3.2	c) Identify and list the types of seasons in PNG and the world.	Characteristics of the four seasons Lesson No: 37	<ul style="list-style-type: none"> The seasons change because the tilt of the earth's axis The four seasons of the world - spring, autumn, winter and summer 	Describe the relationship between the change in the environment and season.	
Earth and Space	5.3.2	c) Identify and list the types of seasons in PNG and the world.	Seasons in PNG Lesson No: 38	<ul style="list-style-type: none"> Papua New Guinea is close to the equator therefore has two seasons – wet and dry seasons 	Identify the two seasons of PNG Explain the wet and dry months of PNG seasons	Appreciate the wet and dry seasons
Earth and Space	5.3.2	d) Explain the characteristics of each season in relation to living things.	Seasons and living things Lesson No: 39	<ul style="list-style-type: none"> Living things change their activities according to the seasons 	Identify mating seasons for a particular animal	
Earth and Space	5.3.2	e) Discuss how weather and seasons affect living things and human activities.	Weather and seasons on Plants Lesson No: 40	<ul style="list-style-type: none"> Plants have physical adaptations that enable them to survive weather extremes of seasonal changes 		
Earth and Space	5.3.2	e) Discuss how weather and seasons affect living things and human activities.	Weather and seasons on Animals Lesson No: 41	<ul style="list-style-type: none"> Animals have physical adaptations that enable them to survive weather extremes of seasonal 		

B. Knowledge Skills Attitudes and Values

				changes		
Earth and Space	5.3.2	e) Discuss how weather and seasons affect living things and human activities.	Effects of weather and seasons on people's activities Lesson No: 42	<ul style="list-style-type: none"> Some animals migrate to warmer areas during winter Weather and seasons can damage property, harm people, destroy crops, disrupt transportation and cut off power and water supplies 	Tell what activities can or cannot be done during different weather conditions	
Life	5.1.4	b) Explain and understand that the Sun is the main source of energy for living things.	Sources of energy for living things Lesson No: 45	<ul style="list-style-type: none"> Energy from most of the energy source is derived in some ways from the sun. 	Investigate energy conversion from one form to another	Show concern for the need to conserve energy usage in our everyday life
Life	5.1.4	d) Explain how plants and animals get energy.	Plants get energy from the Sun Lesson No: 48	<ul style="list-style-type: none"> The sun is the primary source of energy 	Investigate the requirements for photosynthesis	
Physical Science	5.2.3	b) Explain pivot, power point, and working point.	Explain pivot, load, distance in a lever Lesson No: 52	<ul style="list-style-type: none"> A lever consist of a pivot, power point and a working point 	Identify and name the parts of a lever correctly.	
Physical Science	5.2.3	c) Discover the relationship between distance and force in terms of the position of power point from the pivot, the position of working point from the pivot.	Relationship between distance and force (pivot, load and distance) Lesson No:53	<ul style="list-style-type: none"> When the force point or strength changes, the power to tilt the lever changes 	Apply the knowledge of levers when trying to lift heavy loads	Appreciate the use of simple machines in daily life
Physical Science	5.2.3	d) Demonstrate the regularity of levers to balance by using a beam balance.	Using a beam balance Lesson No: 54	<ul style="list-style-type: none"> The weight of two objects is the same when the objects are hooked at each end of a pole at an equal distance from a fulcrum and the pole is held level. 	Measure the weight of objects using a beam balance	
Physical Science	5.2.3	e) Identify examples of uses of levers in daily life.	Uses of levers in daily life Lesson No:55	<ul style="list-style-type: none"> Lever is a simple machine that is used to carry or move loads. 		
Earth and Space	5.3.1	c)Classify different types of rocks into igneous, sedimentary, and	Igneous rocks Lesson No: 59	<ul style="list-style-type: none"> Igneous rocks are formed from molten material. e.g. basalt 	Distinguish igneous rocks from other rocks Describe the process in which	

B. Knowledge Skills Attitudes and Values

		metamorphic rocks			igneous rock is formed	
Earth and Space	5.3.1	c) Classify different types of rocks into igneous, sedimentary, and metamorphic rocks.	Metamorphic rocks Lesson No: 60	<ul style="list-style-type: none"> Metamorphic rock is consist of sedimentary and igneous. It is changed by heat or pressure or both. Metamorphic rock is very hard 	Distinguish sedimentary rocks from other rocks Describe the process in which metamorphic rock is formed	
Earth and Space	5.3.1	D) Identify and list common minerals found in PNG.	Common minerals in PNG Lesson No: 61	<ul style="list-style-type: none"> Mining contributes to the economy in many ways 	Locate in PNG where minerals (copper, gold etc.,) are using different kinds of maps	
Earth and Space	5.3.1	f) Identify and describe examples of uses of rocks and minerals in daily life.	Uses of rocks and minerals Lesson No: 62	<ul style="list-style-type: none"> Since ancient times, rocks have been used for tools, shelter, monuments, yard decorations, fence 	Describe the uses of rocks	
Earth and Space	5.3.1	g) Define and describe the basic process of fossil formation.	What is a fossil? Lesson No: 63	<ul style="list-style-type: none"> 	Describe why fossils are formed in sedimentary rocks	
	5.3.1	g) Define and describe the basic process of fossil formation.	How are fossils formed Lesson No: 64	<ul style="list-style-type: none"> 		
Physical Science	5.2.1	b) Identify the sources of heat and explain what heat can do.	Sources of heat Lesson No: 67	<ul style="list-style-type: none"> Different sources of heat 	Investigate and list the different source of energy	Appreciate that heat is being obtained from many sources.
Physical Science	5.2.1	b) Identify the sources of heat and explain what heat can do	What can heat do? Lesson No: 68	<ul style="list-style-type: none"> Heat is used in many ways, e.g. cooking food, making tools, drying grains 	Investigate the source of heat.	Appreciate the different sources of heat.
Physical Science	5.2.1	c) Identify and explain the different ways in which heat can be transferred.	Heat Transfer – Convection Lesson No: 70	<ul style="list-style-type: none"> When water particles are heated, they gain energy and move rapidly apart. The warmer water rises and colder water moves in to take its place 	Observe the convection of heat in the liquid. Perform the experiment on the convection	Appreciate the occurrence of convection
Physical Science	5.2.1	c) Identify and explain the different ways in which heat can	Heat transfer- Radiation Lesson No: 71	<ul style="list-style-type: none"> The sun transfers heat energy to the earth by the 	Identify other objects that transfer heat	

B. Knowledge Skills Attitudes and Values

				also transfer some heat by radiation		
Physical Science	5.2.1	d) Explore the different uses of heat transfer in daily life situation.	Uses of heat transfer Lesson No: 72	Uses of transfer of heat Conduction- shaping tools Conduction- boiling hot water Radiation- , drying of clothes, cooking food,	Apply the different types of heat transfer appropriately in daily activities Take extra care using heat	Value the different ways of heat transfer Follow instructions/directions given
Physical Science	5.2.1	e) Define and measure temperature using the standard units.	Measuring and reading temperature Lesson No: 73	• A thermometer is an instrument used to measure temperature	Measure temperature using a thermometer	Show ownership by seeking information based on the activity
Physical Science	5.2.1	f) Differentiate between heat and temperature.	Difference between heat and temperature Lesson No: 74	• Heat is a form of energy • The temperature of an object is a measurement of its degree of hotness	Tell the difference between heat and temperature Measure temperature using a thermometer	
Physical Science	5.2.2	d) Explore the brightness of the bulbs when connected in parallel or series circuit.	Advantages and disadvantages of parallel and series circuit Lesson No: 80	• When more bulbs are connected in series, the bulb brightness will decrease, whereas when more bulb is connected in parallel, the brightness is the same	Identify advantages and disadvantages of series and parallel circuits	Appreciate advantage and disadvantage of parallel and series circuit.
Physical Science	5.2.2	b) Identify circuit components and their symbols.	Using symbols to draw circuits Lesson No: 81	• All the components of the circuits have their own specific scientific symbols	Observing Communicating Drawing	Appreciate the symbols used in circuits.
Physical Science	5.2.2	e) List examples of daily use of electric circuits.	Uses of circuit in daily life Lesson No: 82	• A torch is an example of a series circuit. •	Identify several ways in which circuits are used	
Physical Science	5.2.5	a) Identify and explain the properties of chemical change .	Properties of chemical change Lesson No: 84	• New materials are formed as a result of chemical change, during which heat is given off or taken in		
Physical Science	5.2.5	c) Observe chemical changes in matter- combustion and rusting.	Observing chemical change- combustion Lesson No: 85	•		

B. Knowledge Skills Attitudes and Values

Physical Science	5.2.5	c) Observe chemical changes in matter-combustion and rusting.	Observing chemical change-rusting Lesson No: 86	<ul style="list-style-type: none"> Rust is formed as a result of the presence of oxygen and moisture. 		
Physical Science	5.2.5	b) Describe and differentiate physical and chemical change.	Difference between chemical and physical change Lesson No: 87	<ul style="list-style-type: none"> In a chemical change a new product or material is formed whereas in a physical change no new materials are formed. The object/material undergoes physical change, changes in state, shape, size and texture 		

Assessment, Recording and Reporting

Assessment and reporting is an integral part of the curriculum. Assessment is the process of identifying, gathering and interpreting information about students' learning. It is administered to provide information on student's achievement and progress. It directs teachers on their way of teaching and the how students learn.

In standard based curriculum, assessment is viewed not only as a final product (summative), but more importantly as a continual process (formative) that provides pupil performance data to teachers and students regarding their progress towards achieving the intended standards.

What is Assessment?

The term "Assessment" is generally used to refer to all activities teachers use to help students learn and to monitor and measure student progress. It is an ongoing process.

Purpose of Assessment

The purpose of assessment is to inform:

- Students about their progress and achievements in their learning
- Teachers of the progress of students learning in order to adjust teaching and planning to improve students' learning.
- Parents and guardians, about their children's progress and achievements.
- Schools, province and NDOE to make decisions about how to improve the quality of teaching and learning in the education system.
- Other educational institutions and the communities about the standards of teaching and learning strategies, curriculum and resource allocation that may affect students' learning.

Overall assessment is seen as an integral part of the learning and teaching program rather than a separate process.

Types of Assessments

There are three types of assessments in the Standard based curriculum. These are;

- **Assessment as or in;**
- **Assessment for;** and
- **Assessment of**

Assessment **as** and Assessment **for** are also known as Formative Assessments and Assessment **of** is also known as Summative Assessment.

Assessment as or in learning

Assessment **as** or **in** learning is the use of a task or an activity by the teacher in his/her everyday teaching to allow students the opportunity to

Assessment, Recording and Reporting

use assessment to further their own learning. Self and peer assessments allow students to reflect on their own learning and identify areas of strength and weakness. These tasks offer students the chance to set their own personal goals and advocate for their own learning.

Assessment *for* Learning

Assessment *for* learning, also known as classroom assessment, is different. It is an ongoing process that arises out of the interaction between teaching and learning. It is not used to evaluate learning but to help learners learn better. It does so by helping both students and teachers to see:

- the learning goals and criteria
- where each learner is in relation to the goals
- where they need to go next
- and ways to get there.

Assessment *of* Learning

Assessment *of* learning is the use of a task or an activity to measure, record and report on a student's level of achievement in regards to specific learning expectations such as unit tests and end of term or year exams.

Methods of Assessment

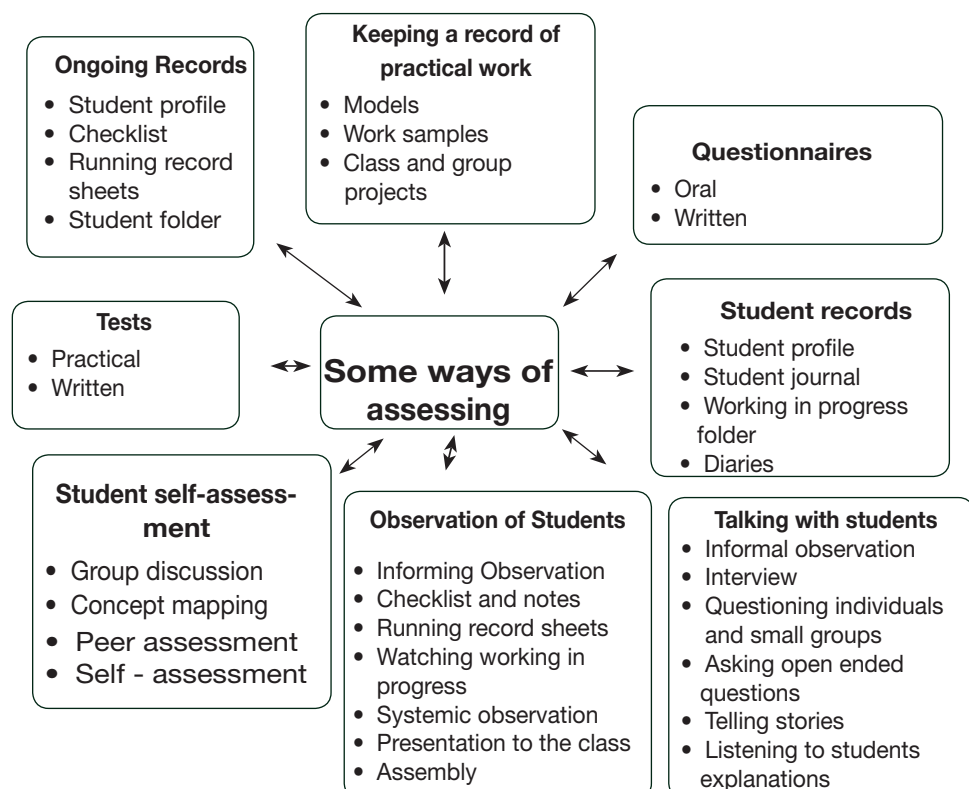

Assessment is an integral part of students learning and can be done using different methods. Below are some of these methods.



Assessment, Recording and Reporting

Assessment Tasks Overview

The Assessment Tasks overview is organised by weeks, strands, units, content standards and performance standards to show the linkage, when the assessment tasks should be conducted, and where the assessment tasks are extracted from which performance standards.

Strand	Unit	Content Standard	Performance Standard	Assessment Task
 Life 	Plants	5.1.1	a) Describe and explain the conditions in terms of water, air and temperature necessary for seed germination.	Describe the process of seed germination
	Animals	5.1.2	a) Identify and explain the reproduction process of different animals - dogs, fish, frogs, birds Identify and describe the hereditary characteristics, similarities and differences in animals	Draw the reproduction process of a bird List similar and different heredity characteristics of animals
	Interaction and Relationship in the environment	5.1.3	a) Explain and identify different types of habitats e) Identify examples of animal adaptations in terms of movement, breathing, protection and food	Select a habitat and cut pictures Find or draw pictures of animals that camouflage
		5.1.4	c) Illustrate and explain the paths of energy in food from the Sun to living things d) Explain how plants and animals get energy.	Draw a diagram to show the flow of energy from the sun to the plants and to animals
 Physical Science	Energy	5.2.1	c) Identify and explain the different ways in which heat can be transferred e) Define and measure temperature using the standard units.	Identify examples of the different ways that heat is transferred in terms of conduction, convection and radiation Measure the temperature of boiling water
		5.2.2	a) Identify, demonstrate and explain the types of electrical circuits d) Explore the brightness of the bulbs when connected in parallel or series circuit.	Demonstrate by connecting wires in parallel and series circuit

Assessment, Recording and Reporting

Strand	Unit	Content Standard	Performance Standard	Assessment Task
 Physical Science	Force and Motion	5.2.3	a) Discover the relationship between force and change in motion of a moving object in terms of speed and direction. c) Discover the relationship between distance and force in terms of the position of power point from the pivot, the position of working point from the pivot	Identify the effects of force on a moving object Design a model of a lever with beam and pivot
	Matter	5.2.4	b) Investigate the process of changes in states - solid to liquid, liquid to gas and vice versa c) Describe the relationship between change in temperature and change in states of matter	Name the process when matter changes from: - Solid to liquid - Liquid to gas - Gas to liquid Measure the temperature in various stages of matter
	Matter	5.2.5	a) Describe and differentiate physical and chemical change d) Identify and explain examples of chemical changes in daily life	Define physical and chemical change List examples of chemical and physical changes that occur daily
	Rocks	5.3.1	b) Discover the characteristics of different types of rocks c) Identify and list common minerals found in PNG. g) Define and describe the basic process of fossil formation.	Describe how different rocks are formed List common minerals found in PNG and identify the provinces/ places they are found Describe the process of soil formation
Earth and Space	Space	5.3.2	a) Identify and explain the different types of clouds c) Identify and list the types of seasons in the world and PNG e) Discuss how weather and seasons affect living things and human activities	Name the different types of clouds and explain them Name the four main seasons of the world and the two seasons of PNG Identify the different adaptations that living things go through during seasonal change

Assessment, Recording and Reporting

Assessment Task Samples

Assessment Task sample: 1

Strand: Life

Reference: Primary Science Syllabus.

Page:

Unit:	Plant
Content Standard	5.1.1
Performance Standards	a
Assessment Task	Draw the different stages of seed germination and briefly explain each stage.
Assessment Criteria	1. the stages are correctly drawn 2. brief explanation of each stage 3. development of seed parts labelled correctly
Assessment Method	Assessment
Recording & Reporting Method	Checklist

Assessment Task Sample: 1

Seed Germination Process

Stage 1

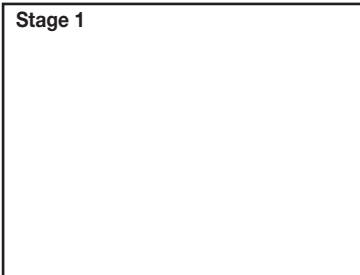

Stage 2

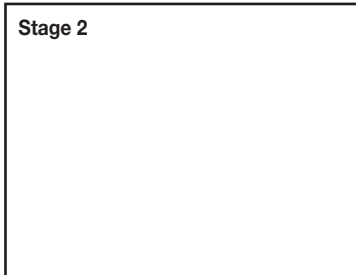

Stage 3

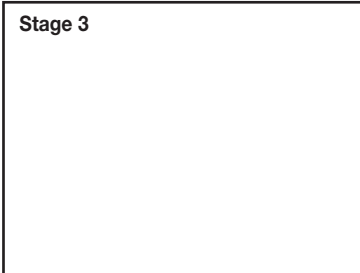

Stage 4

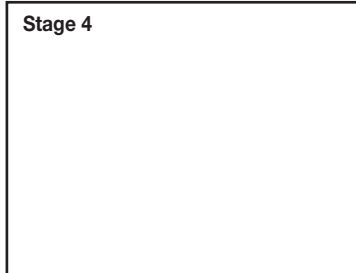

Assessment, Recording and Reporting

Sample Group Check List: Group- Kumul

Assessment Task 1.		Marking Code Keys :		
		1. Well done confident in all statements 2. Part response given with some confidence 3. Limited or little response to each statement.		
Name:	C Statement 1. Arranged all stages of plant life cycle in correct order	C Statement 2. Explanation of each stage is meaningful	C Statement 3 3. Correctly name and spell the parts of a seed where germination begins	C Statement 4. Shown confidence to speak in front of group members
Pidi	1	2	1	1
Kaytee	1	3	1	2
Saloiri	2	2	3	2
Mipa	3	3	1	2
Esgo	2	1	1	2

Assessment Task:

a)



b)



Class Checklist

Assessment Task 1.		Marking Code Keys :	
		A : Achieved PA : Partly Achieved NA : Not achieved	
Class List (Total number of students on roll)	C1. Connections are done correctly	C2. Diagrams drawn cor- rectly with all symbols	C3. All components of the circuit included
1. Claudia			
2. Drusilla			
3. Timothy			
4. Rihoi			

Assessment, Recording and Reporting

Assessment Task Samples

Assessment Task sample: 3

Strand: Physical Science

Reference: Primary Science Syllabus.

Page:

Unit:	Matter
Content Standard	5.2.4
Performance Standards	c. Describe the relationship between change in temperature and change in states of matter
Assessment Task	Measure the temperature of water from liquid water to gas and plot the results on a line graph (if time does not allow, you can use the result from lesson # 36)
Assessment Criteria	1. Table of results presented 2. Correct axis for time and temperature 3. Graph drawn, neatly with free-hand
Assessment Method	Work sample
Recording & Reporting Method	Individual Checklist

Assessment, Recording and Reporting

Time	Temperature	Comments
0		
2		
4		
6		
8		
10		
12		
14		
16		

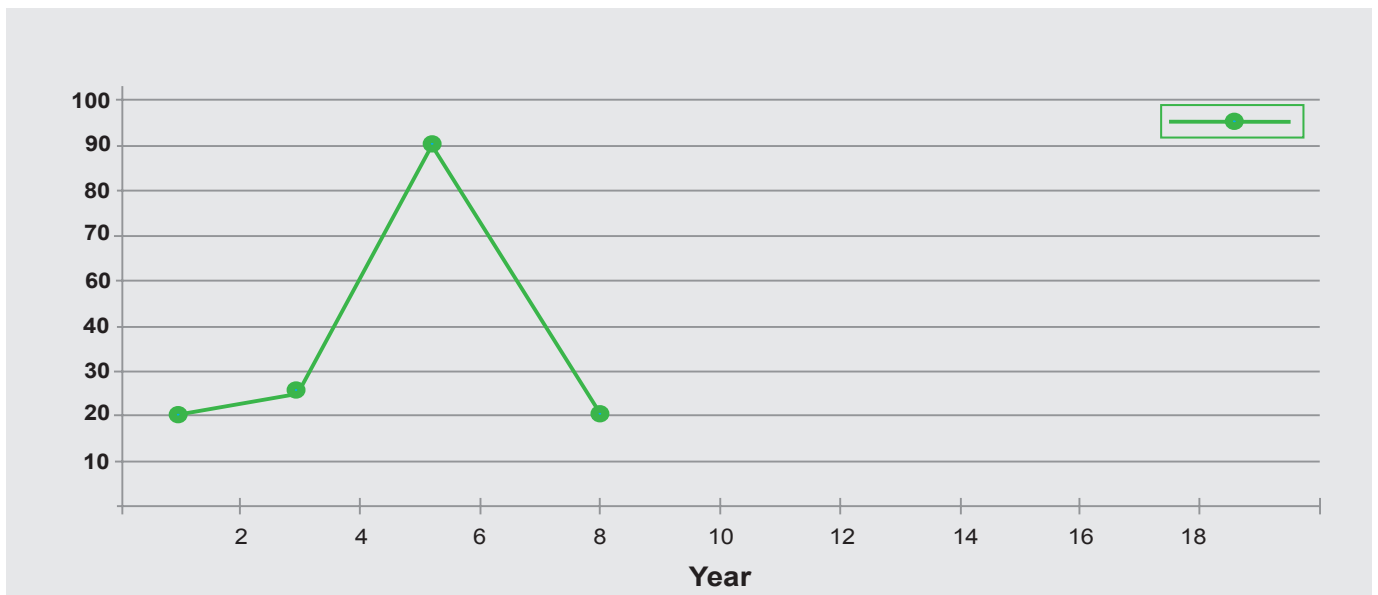

Assessment, Recording and Reporting

Assessment Task Samples

Assessment Task sample: 3

Strand: Earth and Space

Reference: Primary Science Syllabus.

Page:

Unit:	Our Earth
Content Standard	5.3.1
Performance Standards	d
Assessment Task	Draw the PNG map and identify the different places where minerals are found
Assessment Criteria	1. Map of PNG drawn neatly 2. Places identified with the type of minerals
Assessment Method	Work sample
Recording & Reporting Method	Anecdotal notes

Map of PNG



Resources

Strand: Life

No	Teacher Resources	Student Resources
1.		Plant Growth Chart
2.		Reproduction process of Animals chart
3.		Adaptation and Habitat Chart
4.		Food chain and Food web Chart
5.		
6.		

Strand: Physical Science

No	Teacher Resources	Student Resources
1.		Heat energy Chart
2.		Circuit symbols Chart
3.		Simple Machine -Lever Chart
4.		Three states of matter chart
5.		
6.		

Strand: Earth and Space

No	Teacher Resources	Student Resources
1.		Properties of Rock and Mineral Chart
2.		Seasons of the World Chart
3.		
4.		
5.		
6.		

Glossary

Words	Definitions
Adaptation	the process of change by which an organism or species becomes suited to its environment
Anemometer	a device used for measuring the speed of wind
Barometer	an instrument used to measure air pressure and predict changes in the weather
Camouflage	the use of any combination of materials, coloration or illumination for concealment either by making animals, objects hard to see
Carnivore	an animal that eats another animal for food.
Chemical change	when something undergoes a “chemical reaction” and a new substance is formed as a result.
Circuits	a closed pathway in which electricity flows through
Condensation	the process in which water changes from water vapour to liquid water
Conduction	the transfer of heat between substances that are direct contact with each other.
Convection	the transfer of thermal energy from hot places to cold places.
Ejaculate	to discharge a body fluid, especially semen
Endangered species	a species which has been categorized as likely to become extinct
Evaporation	the process in which water changes from liquid water to vapor vapour
Fertilisation	the action or process of fertilizing an egg or a female animal or plant, involving the fusion of male and female gametes to form a zygote
Fossils	the remains or impression of a prehistoric plant or animal embedded in rock and preserved in petrified form.
Germinate	to grow and put out shoots after a period of dormancy
Germination	the process by which an organism grows from a seed
Habitat	the natural environment in which a species or group of species lives
Heredity	the passing on of physical or mental characteristics genetically from one generation to another
Igneous rocks	rocks formed from the solidification of molten rock material.
Metamorphic rocks	rocks that are formed as a result heat, pressure and chemical process
Molecules	a group of atoms bonded, together, representing the smallest fundamental unit of a chemical compound that can take part in a chemical reaction
Parallel Circuit	a closed circuit in which the current divides into two or more paths before recombining to complete the circuit
Photosynthesis	the process used by plants make their own food to convert light energy, air and water.
Porous	admitting the passage of gas or liquid through pores or interstices
Radiation	a method of heat transfer that does not require any contact between the heat source and the heated object. heat is transferred through empty space by infrared radiation
Rain gauge	an instrument used to measure the precipitation in a certain amount of time
Seasons	periods in a year marked by specific weather conditions, temperatures and length of day. there are four seasons (autumn, spring, winter and summer)
Sedimentary rocks	the types of rocks that are formed by the deposition and subsequent cementation of that material at the earth’s surface and within bodies of water
Series Circuit	An electric circuit connected so that current passes through each circuit element in turn without branching

References

NDOE 1981, *Science Teacher Grade 3*, NDOE, Waigani

NDOE 1981, *Science Teacher Grade 4*, NDOE, Waigani

NDOE 1996, *Radio Science Grade 4*, NDOE, Waigani

NDOE 1996, *Radio Science Grade 5*, NDOE, Waigani

NDOE 2016, *Primary Grades 3, 4 & 5 Science Syllabus*, NDOE, Waigani

Idea Book 1993, Longman Cheshire

<http://bijlmakers.com/insect/insect-bodyparts>

<http://eschooltoday.com/science/states of matters>

<http://eschooltoday.com/clouds/types of clouds>

<http://eschooltoday.com/rock/types of rocks>

<http://msttpagotech.pbworks.com>

<http://msttpagotech.pbworks.com>

<http://www.quora.com/science/states of matters>

<http://www.slideshare.net/nancychalkley/matter-powerpoint-15920171>

<http://examples.yourdictionary.com/examples-of-chemical-properties.html>

<http://www.sciencekids.co.nz/sciencefacts/humanbody/skeletonbones.html>

<http://www.ducters.com/science/muscles.php>

Appendix

1. Guided Lesson Template

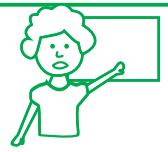

Strand: _____

Unit: _____

Topic: _____

Content Standard: _____

Lesson Title: _____

Objective: By the end the lesson the student will be able to:

- _____

Key concepts

- _____
- _____
- _____

Knowledge, Skills, Attitudes and Values (KSAV)

Skills	Attitudes	Values

Materials/Reference: _____

Teachers Notes:

Introduction:

Body:

Teachers Activities

Students Activities

Conclusion:

Evaluation:

Appendix

Electricity Worksheet # 1

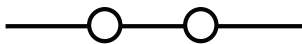
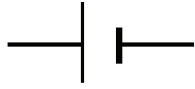

Appendix

Electricity Worksheet # 2

Can you label these symbols?



.....



.....



.....

Look at the following circuits. Can you work out how many of each component is in each circuit?

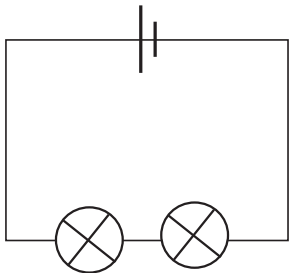

There are
.....
.....

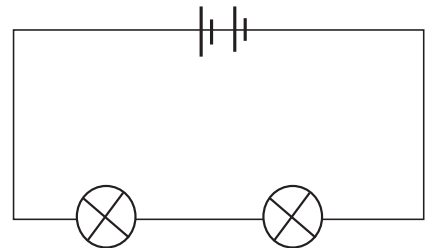

There are
.....
.....

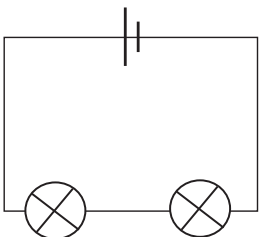

There are
.....
.....

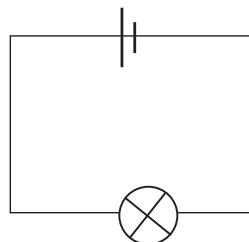

There are
.....
.....

'FREE ISSUE - NOT FOR SALE'